



# RHONDA'S™

## IRREGULARS

1643

BATTLETECH®



FASA  
CORPORATION





# CREDITS

## Writing

Blaine Pardo

## Development

David Ladyman  
Sam Lewis

## Editorial Staff

*Senior Editor*

Donna Ippolito

*Assistant Editor*

Sharon Turner Mulvihill

## Production Staff

*Art Director*

Dana Knutson

*Cover Art*

Jim Holloway

*Cover Design*

Dana Knutson

*Illustration*

Mark Fullerton

Terry Pavlet

Dana Knutson

*Layout*

Tara Gallagher



BATTLETECH, 'MECH, BATTLEMECH and MECHWARRIOR are Trademarks of FASA Corporation, registered in the U. S Patent and Trademark Office. RHONDA'S IRREGULARS is a trademark of FASA Corporation. Copyright © 1991 FASA Corporation. All Rights Reserved. Printed in the United States of America.  
Published by FASA Corporation • P.O. Box 6930 • Chicago, IL 60680

# CONTENTS

<b>INTRODUCTION</b>	<b>4</b>
How to Use the Scenarios	5
<b>SNORD'S IRREGULARS</b>	<b>6</b>
<b>TABLE OF ORGANIZATION AND EQUIPMENT, 3026-3037</b>	<b>13</b>
<b>TABLE OF ORGANIZATION AND EQUIPMENT, 3037-3051</b>	<b>14</b>
<b>COMMAND COMPANY PERSONNEL, 3050</b>	<b>16</b>
Cranston Snord	16
Rhonda Snord	17
Charlotte Deblois	18
Arnold Ling	19
Adrian Macleod	20
Dennis Maltesta	21
Anthony Pryor	22
Walker Roche	23
David Rowsch	24
Marcos Shake	25
Tempest Storm	26
Cyndos Thomlinson	27
Sharonus Wayne	28
<b>RECOVERED STAR LEAGUE EQUIPMENT</b>	<b>29</b>
Excalibur	30
Spartan	31
Padilla Heavy Artillery Tank	32
<b>SCENARIOS</b>	<b>33</b>
Tanks a Lot	34
Snakes in the Grass	36
Battle for the Throne	38
Farewell to a Friend	40
Fistful of Crystals	42
A Few Crystals More	44
Everything Old Is New	46
Storm's End	48
<b>CAMPAIGN: OPERATION MERLIN</b>	<b>50</b>
<b>JADE FALCONS ROSTER</b>	<b>52</b>
<b>SCENARIOS</b>	<b>54</b>
Warrior's Challenge	54
Grand Melee	56
Camelot's Gate	58
Pitched Battle	62
Men-At-Arms	66
Birth of a Legend	68



# INTRODUCTION

Clinton, 24 December 3042

Thelos Auburn's eyes blinked open under dim light. As he focused, he saw that the light came from aging ceiling panels. It stung at first, but with the pain came consciousness. His chest labored to breathe, aided by some mechanical device just out of sight. Tubes filled his nostrils and forced cool air into his lungs. He tried to sit up, but was unable to. Looking back up at the ceiling, he could make out a dull, faded image painted across it. He had seen this image thousands of times before, but only on reference disks. It was a Cameron Star, the symbol of the Star League. His surprise made him cough, and his dry tongue tasted the salt of blood, his own blood.

Cranston Snord leaned into his field of vision, blocking the star on the ceiling. Age and time had taken their toll on the mercenary, yet his eyes still held a roguish twinkle. "Cran...s...ston," Thelos stammered. "What hap...p...pened?" He coughed again, and pain tore through his frame. A great shadow gathered over his mind, like a curtain beginning to fall.

"Relax, my old friend. time is short." Cranston touched him soothingly. "You were in the museum's main library when you suffered some sort of seizure. That was two days ago."

Thelos glimpsed the shadow again. He slowly blinked his eyes, then admitted the obvious. "...I am dying."

"Before I brought you here, I had the best doctors on the planet jumped to Thelos. They said you would die in a few hours, but you outfoxed them. Unfortunately, though, there are some treasures even I cannot steal and pass on. One of those is life. That is why I brought you here. This," he gestured about him, "this is a fitting final quarters for a historian like you. It is a place for truth between old friends."

"I must...must know. Where did you...come from? Tell me of Wolf. Cran...s...ston, tell me...who are you really?"

His voice died away in exhaustion. Cranston smiled slightly, as he considered. "Very well then. The whole truth. I am going to tell you something that no other historian in the Inner Sphere knows. I know what happened to Aleksandr Kerensky and the Exodus fleet!"

The mention of Kerensky brought a flicker of life to Auburn's eyes as Cranston continued. "The General took his people far from here, and after a year of flight they settled on five small worlds. The Father of Us All led our forefathers well, and soon they established other colonies. For a short time, they thrived. But as it did here, greed reared its ugly head. Petty bickering became outright civil war. General Kerensky wanted to keep the worlds united, to maintain the soul and essence of the Star League, but he could not. Time took his life, too, Thelos."

Cranston stood just within Auburn's field of vision, with the Cameron Star hanging over him like a faded flag. "The civil war that broke out made your Succession Wars look like tea parties. Only Nicholas Kerensky, the General's son, held his forces back. They shunned the war, protecting the technology and the innocents. In the end he came and rescued those who had survived. If not for Nicholas, all of the Exodus would have perished.

"In the aftermath of that devastating war, Nicholas founded the Clans, a warrior-based society. The survivors were separated into castes, with the warrior caste the most respected. Warriors are a proud people, sworn to uphold their Star League heritage. The Clans rediscovered the technology they had lost, and

eventually even surpassed what your houses possess now. Through eugenics, they created a master warrior breed. The marvel of it all staggers the imagination!"

Snord's narrative trailed off as he became lost in his memories. A moan from his patient recalled him to his tale.

"The Clans were considering a return, to restore the Star League to the Inner Sphere. But first they needed information. The great experiment, Wolf's Dragoons, was devised."

Thelos' mind reeled. He had always suspected that Wolf's Dragoons had sprung from the remnants of the Star League, and now he knew it to be true.

"Jaime Wolf and I grew up together. On the trip to the Inner Sphere, he decided that I might be something of a loose cannon among the Dragoons, and I have to admit he was probably right. So we created a simple plan. I have always had an urge to collect historical artifacts. I was to infiltrate the Inner Sphere just after the Dragoons arrived. While they worked the Houses, I would form a small mercenary unit and gather additional information for Jaime's Dragoons. In particular, I was ordered to track down Star League caches and other remnants of lost knowledge.

"But life here was different than among the Clans. The freedom was alien to us at first, but we grew to like it. Soon we cut off communication with the clan that had sent us, Clan Wolf. Now I fear, as does Jaime, that they will soon return. And with the return of the Clans, the end of the Houses will soon be approaching as well."

Sweat suddenly chilled Thelos. The shadow in his mind loomed, seeking to enfold him. He resisted it desperately, determined to learn all that he could before the end.

"I may be an 'amoral looter,' my old friend, but I also take pride in my mission, and so does my daughter. This room," he indicated with a sweeping gesture, "was part of a Castle Brian, hidden here on Clinton for over 250 years. I found it and built my museum on top of it. You are in a Star League Operating Room, being kept alive by machines of the SLDF.

"The League is gone, and there is no room for what the Clans believe to be their Star League. They do not know the Inner Sphere as I do. I fear the horror of the war that must result when they finally invade."

Thelos Auburn coughed once again. "Mi...sh...sha," he stammered. He thought of his daughters and his grandchildren. What bloody future awaited them with the coming of these Clans?

It was a future he would not live to see. His mind confused the words of Cranston, Wolf, Kerensky, and the mysterious Clans his old friend spoke of.

"I had ComStar send a message to Misha, but I am afraid she will not reach here in time to say her goodbye."

Cranston felt his face redden and tears well up in his eyes. He lifted a small medallion and chain from his neck and draped them over Thelos Auburn's head. "This belonged to a great man once. In the Clans' way, he was the founder of a Blood Line, the first of a Bloodname.

"In another time you would have worn it with dignity and pride, but now it is a piece of history. I want you to wear it now. May it shield you in the next life..."

The last image in Thelos Auburn's mind was a glimmer from the Star League Medal of Valor. Time had finally overtaken the historian, but at least he knew the truth.

## HOW TO USE THE SCENARIOS

Each of the scenarios in this book covers a battle involving Snord's Irregulars, picking up in 3025 where the scenarios in **Cranston Snord's Irregulars** left off. Several of the scenarios are related, covering portions of the campaign for Camelot Command. Players should consult **Campaign Rules** for further details of those scenarios.

The scenario rules include all the information necessary to understand and play out the encounter. In all but one of the scenarios, standard **BattleTech Compendium** rules are used. The fifth scenario of Operation Merlin, the campaign for Camelot Command, is a **BattleTroops** scenario, and so uses **BattleTroops** rules. Each scenario begins with a personal account of the engagement and ends with a brief historical framework for the battle.

The Table of Organization and Equipment includes information on two new Star League-era 'Mechs and a self-propelled artillery piece.

Each **Game Set-Up** section provides the specific information needed to play that scenario. This includes instructions on how to lay out the map sheets and directions for special terrain features.

**Defender** and **Attacker** forces for each scenario are described in detail. Also noted is each force's starting position on the map, and where and when reinforcements enter (if any are available to either side).

The **Victory Conditions** determine the outcome of the encounter and vary from scenario to scenario. In combat, it is rare for an action to continue until one side is eliminated. For this reason, the **Victory Conditions** usually list special objectives for one or both opponents.

Destruction of units is often part of the victory conditions. **Destroying a Unit** is defined in the **BattleTech Compendium** (p. 30) and the **BattleTech Manual** (p. 24).

Finally, if the scenario uses optional **Compendium** rules or special rules not covered in the standard **BattleTech** rules, they are described in the **Special Rules** section.

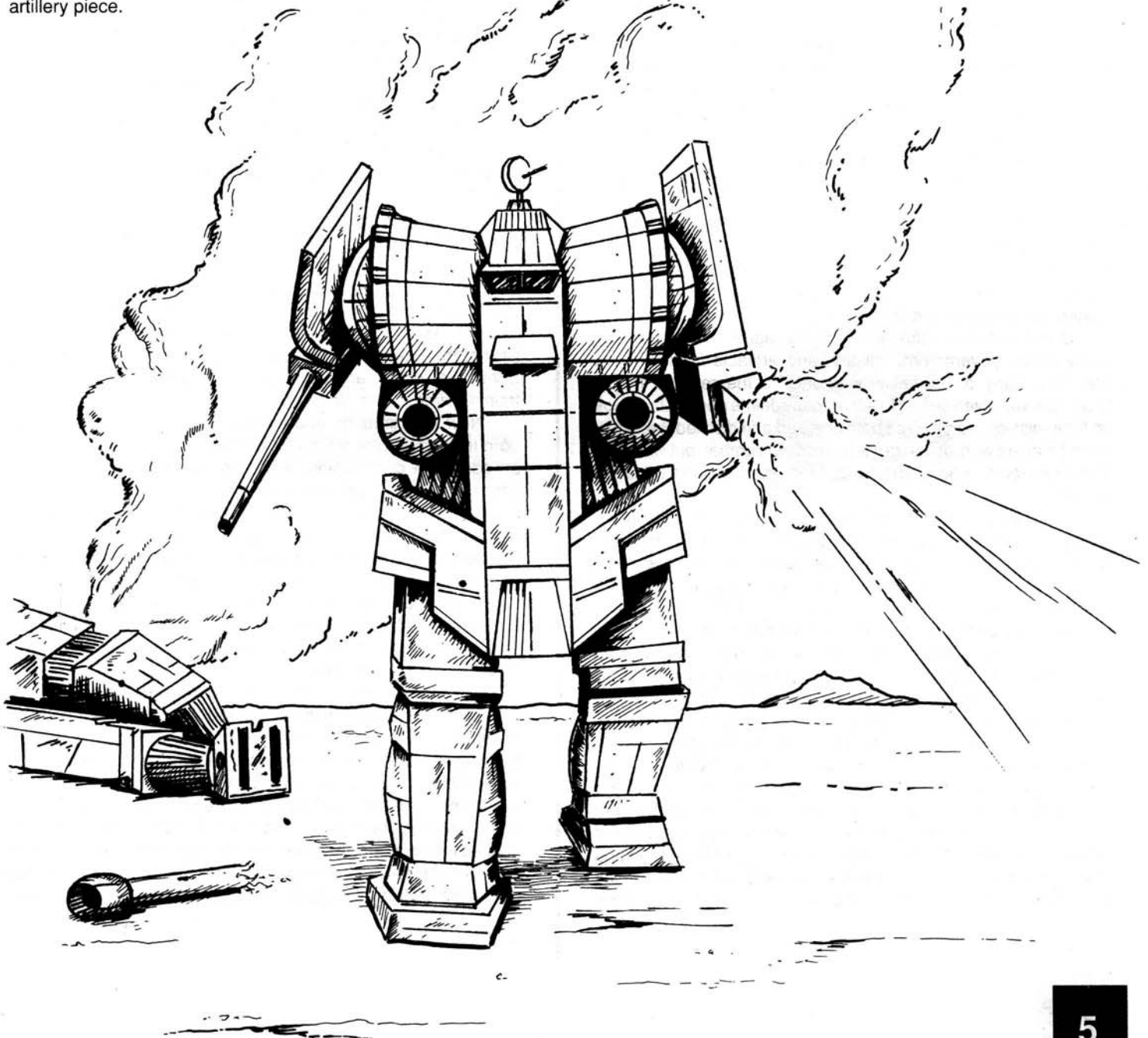

# SNORD'S IRREGULARS

*Some men are born to greatness. Others have it thrust upon them. Me? I punted.*

—Cranston Snord, 3050

## INCEPTION

Khan Kerlin Ward of Clan Wolf knew that the Clans would one day move to fulfill what the Crusaders felt was their destiny, to invade the Inner Sphere and re-establish the Star League. Khan Ward felt that the timing was not right, and that the mission of the Crusading Clans was not proper.

When the Great Debate came to a head within the Grand Council of the Clans, Khan Ward offered a compromise. He proposed that five regiments of warriors be sent into the Inner Sphere to gather intelligence and to test the mettle of its forces. Equipped with retro-fitted technology and posing as mercenaries, they would be able to learn the strengths and weaknesses of the Inner Sphere governments. For Khan Ward, it was a gamble, designed to buy the Inner Sphere time. For the Inner Sphere, it was the birth of a legend, the coming of Wolf's Dragoons.

For the most part, the Dragoons were freebirth warriors, considered inferior by the Clans to the genetically bred truebirths. Clan Wolf had a large number of freebirth warriors, more than enough to form the five regiments of Wolf's Dragoons. It was a good way to discard troublemakers and those freebirths who would not conform to the rigid dictates of Clan society.

One of these was Cranston, a warrior who took the surname Snord as part of his cover for the mission. A strong freebirth warrior of exceptional fighting ability, Cranston clearly was uncomfortable within Clan society. Born the only child of a Merchant Caste family, he worked hard to earn a position in the Warrior Caste's lower levels. He was vastly skilled in combat, yet he often balked at Clan rules and traditions.

Snord was fascinated with the Star League, and his constant study of the government, military, and artifacts from that era bothered many of his fellow warriors. To the relief of many, Cranston was given orders to accompany Jaime and Joshua Wolf on their mission. Jaime Wolf both admired and disliked the misfit. He felt that the warrior had great prowess in combat, but was sure that Cranston's nonconforming attitude was destined to cause trouble.

Striking a last blow for eccentricity, Cranston insisted that his young daughter Rhonda be attached to the mission. Such father/child relationships among the Warrior Caste were rare, and many considered these relationships to be abominations. However, despite her father's unorthodox approach to training and warfare, Rhonda grew up to be a skilled MechWarrior in her own right.

After considerable deliberation, Jaime met with Cranston and devised a plan to make use of his unique talents and abilities. While Wolf's Dragoons would begin their Inner Sphere service with House Davion, Cranston and a smaller team were to approach House Steiner and gain service there, forming their own mercenary unit. This unit would be composed mostly of Inner Sphere natives, and would act as additional eyes and ears for the Dragoons. In particular, they were to search for buried treasure. The Star League Defense Forces had left behind hundreds of hidden military bases. The Exodus fleet had maintained records of where many complexes and caches were hidden, but many other records had been lost during the more violent years of the

Clans' formation. Most of these bases, known and unknown, had been discovered by the warring houses, but the Wolf brothers were sure that others still existed undiscovered.

When Wolf's Dragoons appeared in the Inner Sphere on 11 April 3005, Cranston Snord was with them, commanding a battalion of BattleMechs in the Epsilon Regiment. Following Colonel Wolf's orders, Cranston devised an excuse for Wolf to dismiss him from the Dragoons. In Jaime Wolf's own words, "I'm giving you enough rope to hang yourself, so do it right."

An opportunity presented itself in the raid on Halloran in early 3006. Cranston Snord ordered his battalion to attack a Liao outpost for the sole purpose of recovering a rare meerschaum pipe collection. His action infuriated the other warriors of the Dragoons, and provided sufficient grounds for his ouster.

Jaime Wolf publicly berated the MechWarrior and angrily discharged him from the Dragoons. With one stroke, Cranston had proven himself a skilled warrior, given birth to tales of his eccentricity, and added to the reputation of Wolf's Dragoons as an elite mercenary unit. Adopting the guise of a fanatical collector, Snord began the meandering journey that would lead to a bar on Crossing and the legendary poker game of 3007, where he won his first independent unit.

This time, Cranston continued to pursue the mission Colonel Wolf had given him. His year's research indicated that several undiscovered Star League caches were located near the Lyran Commonwealth/Free Worlds League border. His transfer of the Irregulars to this border gave him ready access to the scouting and research information he was likely to need.

## SNORD'S IRREGULARS

Other Dragoons who had been similarly cashiered or had quit, including Shalimar Windall and Terry and John Malvinson, signed on with the new unit. The Malvinson brothers brought Rhonda. They had been charged with looking after her while Cranston established himself. They also brought Samuel Sneede, a Technician Caste orphan who preferred Warrior Caste training over a return to the Clans.

New backgrounds and identification disks for these Clan-born Irregulars were forged by Wolfnet. Terry Malvinson carried an additional commission, which he passed on to Sneede 20 years later. Under specific orders from Joshua Wolf, he was sworn to kill Snord should the slightly off-base officer ever threaten to expose the true nature or origin of Wolf's Dragoons. Using specially coded messages passed through couriers to avoid the prying eyes of ComStar, Snord's Irregulars were able to feed a vast amount of information to Jaime and Joshua Wolf during the first years of the Dragoons. In return, dummy accounts and corporations funded by the Dragoons accomplished much of the initial financing of the Irregulars.

From his review of the scant records available to him, Cranston suspected that the long-lost Castle Brian was buried on the world of Clinton. During initial contract negotiations with the Lyran Commonwealth, he proposed that the Irregulars establish a permanent base on this world. Arriving there to consider its suitability, he purposely dragged out negotiations while the other Clan-born Irregulars searched for the lost SLDF facility. Once they located it, Cranston stipulated that the tract of land on which it lay hidden be deeded to the Irregulars. The LCAF was happy to deed the seemingly worthless land, never knowing what they had given up.



## EARLY YEARS

When the Dragoons departed to provide their report to the Clans in 3009, Cranston left his unit, allegedly checking into a hospital for surgery. Travelling with the rest of the Dragoon command staff, he too filed a report, listing five empty Star League facilities he had discovered. In 3011, the Irregulars, rejoined by their commanding officer, accepted a raiding mission with the newly formed Kell Hounds. Its success added to the hatred House Marik and the Free Worlds League was developing for the Irregulars.

In 3014 Wolf's Dragoons, in the service of House Marik, struck the world of Loric, defended by Snord's Irregulars. For the most part, little actual fighting took place. The engagements that occurred were always stalemated, with one side or the other pulling back rather than driving for the kill. Cranston and his unit managed to capture three Dragoon MechWarriors, which he returned personally to Jaime Wolf.

During the peak of the Third Succession War, on the bitterly cold world of Phecda, the Irregulars made a significant discovery. Cranston had a lead on a lost *Colossus* Class DropShip buried on the world, and managed, after nearly losing Rhonda to a Marik attack, to find and recover the DropShip's cargo.

The cargo consisted of a large stockpile of Star League BattleMechs, many equipped with lostech devices, making them priceless. Also uncovered were substantial stores of ammunition and vital repair parts. Cranston made sure that all the Lyran Commonwealth recovered were common BattleMechs, stripped of any superior weaponry or sophisticated systems.

Under Shorty Sneed's direction, the advanced weapons and BattleMechs were smuggled back to Clinton over the course of the next year. Once assembled, they were studied, repaired, and tested in the hidden Irregulars base. By command of Jaime Wolf, none of these were put into service with their lostech devices, though both Cranston and Rhonda felt that decision was wrong. Cranston reached one compromise with Colonel Wolf, however: he was allowed to add a second company to the Irregulars, using BattleMechs without lostech. While Cranston and Rhonda wanted more, they tempered their desires in view of Jaime Wolf's express orders. By the end of 3025, the Irregulars were able to muster almost a full battalion of BattleMechs and support forces.

## FOURTH SUCCESSION WAR

The initial plans for Operation Götterdämmerung left Snord's Irregulars on garrison duty, providing a military presence on worlds in the rear of the operation. Rhonda was not pleased with the duty, but it did give newer Irregulars a chance to train in a wide range of environmental conditions. Cranston's research on Clinton paid off in early winter, 3028, when he discovered references to an SLDF base on the Combine world of Volders. Furthermore, he thought that the vaults of the long-destroyed city of Hopkins on Volders might hide a stash of computer data chips, smuggled off Terra shortly before the fall of the Star League. References in old SLDF manifests indicated that the chips contained information believed lost, on surveys in the far reaches of the Periphery. Although these references were vague, Cranston was so sure of their potential worth that he convinced the LCAF to add elements of the Irregulars to the Second Narhal's Raiders' attack on Volders.

This action was critical to the long-term success of Snord's Irregulars. During the initial drop, the Second Narhal's Raiders heavy armor forces made significant advances near the ruins of Hopkins. However, two companies of light garrison 'Mechs quickly tied down the Raiders' armor, circling them in the city's rubble. Rhonda Snord led the Irregulars' command company into the outskirts of the ruins, using the mounds of debris to hide them from enemy sensors. In a series of quick and deadly ambushes, the lighter forces were routed by the Irregulars and the Narhal armor (**Tanks a Lot**).

Now in control of what had once been Hopkins, the Irregulars began searching for the data chips, but to no avail. Four days later, only a handful of artifacts had been recovered. Meanwhile, Narhal's Raiders continued to encounter strong resistance to the north. Rhonda was reluctant to give up their search, but the Irregulars were needed. She began a long-range probe expected to eventually parallel the Raiders' position. While still 40 kilometers behind the Raiders, the Irregulars' support company sighted a small command bunker defended by a handful of light 'Mechs and troops. Carefully avoiding detection, Rhonda ordered both companies of the Irregulars to attack.

The Irregulars had stumbled onto the nerve center for the planetary defense. From hidden tunnels around the base, several lances of heavy BattleMechs emerged, surrounding the Irregulars. Snord's support infantry, trained in anti-'Mech fighting, leaped into the fray. Within minutes, Rhonda had the Regimental CO in leg irons, as well as most of his surviving staff. The loss of command shattered the First Volders Regiment's resistance against the Second Narhal's Raiders. Four days later, the remaining defenders surrendered and the world officially fell to Commonwealth control (**Snakes in the Grass**).



# SNORD'S IRREGULARS

From interviews with the captured officers, Rhonda learned that the command base had been established on old SLDF ruins accidentally uncovered by the garrison forces three months earlier. She ordered a full search of the area to be carried out in secret by her most trusted personnel. They uncovered several half-buried tunnels leading into the nearby hillsides. Despite the risk of cave-ins, Rhonda and her forces pressed on, and eventually uncovered a Star League cache less than a kilometer from where they had fought the local forces. Inside were more than three dozen Star League vehicles and BattleMechs, as well as carefully stored supplies and ammunition. She had the equipment quietly removed and loaded aboard her unit's DropShips. Six weeks later, the first shipment of these priceless weapons of death were securely stored in the hidden facility under the Irregular's museum.

Using the Fourth Succession War as a cover, Cranston negotiated for the Irregulars to conduct several small raids on the Free Worlds League planets of Connaught and Bordon. These incursions were designed to draw Marik defenders away from attacks by the Tikonov Republic against Procyon and Wasat. During the second such raid on Connaught, Snord's Irregulars secured several large bags of antique coins over 2,000 years old. The cost was severe, however. Shalimar Windall, one of the unit's most experienced MechWarriors, fell to make good the Irregulars' escape (**Battle for the Throne and Farewell to a Friend**).

As the Fourth Succession War wound down, Snord's Irregulars were rotated back to Clinton for repair and regrouping. During that time, Cranston and Rhonda left the unit for over three months, meeting secretly with Jaime Wolf and other members of Wolfnet to exchange information on the war effort and battlefield performances. Cranston was deeply moved by the loss of many of his former comrades within the ranks of Wolf's Dragoons and took part in the Clan ceremony of "Shied," the recognition of warriors who have died in combat.

During the last days of their meeting, Jaime confided in the Snords that the Clans were planning to return in the near future. With this return, Jaime foresaw an Inner Sphere consumed by war. He showed them his projections of losses for the Inner Sphere worlds, and provided convincing arguments for the Dragoons to dissociate themselves from their Clan brothers and sisters. Colonel Wolf gave Cranston and Rhonda a special mission, one suited to their unique abilities. Other members of Wolfnet had uncovered information indicating the presence of a hidden 'Mech construction facility concealed on the world of Outreach. The Irregulars were to request permission from the Archon to garrison the world and search for artifacts, meanwhile tracking down this suspected hidden factory.

While both the Snords agreed to the mission, Rhonda repeated her request for the use of the Star League 'Mechs that had been uncovered on Phecda and Volders. Rhonda felt strongly that if such 'Mechs had been available to the Irregulars during the war, several skilled MechWarriors would not have died. Jaime once again countered that the Irregulars having such 'Mechs might upset the current balance of Successor State technology. In the end Rhonda agreed, somewhat bitterly, to refrain from using the equipment until Jaime Wolf granted his permission.

In early 3030 Snord's Irregulars requested permission to garrison and investigate a reported cache of artifacts on Outreach. Snord initiated the request, but the Federated Commonwealth High Command had their own reasons for supporting such an investigation. The High Command told Snord privately that

Wolf's Dragoons had asked for the world as their base. The Federated Commonwealth wanted Snord to make sure that nothing of unexpected value was available on Outreach before they turned it over to the Dragoons. For more than six months, the Irregulars surveyed Outreach, secretly passing their findings through Wolfnet to the Dragoons. Cranston finally reported to the High Command that the world was clear.

## WACO'S VENGEANCE

Word occasionally passed along the MechWarrior grapevine suggesting a possible association between Snord's Irregulars and Wolf's Dragoons. This gossip eventually caught the attention of Colonel Wayne Waco of Waco's Rangers. This suggested association re-opened an old wound with Waco, who had sworn revenge against the Dragoons for the loss of his son. Waco met Cranston in a small bar on Tharkad in March 3032, and demanded to know the relationship between the two mercenary units. Cranston, always flip, remarked that it was none of Waco's business, but if he was really concerned, Jaime Wolf and he were close friends.

The next day the Rangers broke their contract with House Steiner and joined House Marik, the Irregulars' old enemies in the Free Worlds League. Janos Marik, bitter over years of humiliation at the hands of Snord's Irregulars, used the Rangers as the tool of his revenge. In May of 3032, Cranston received a package from Colonel Waco informing Snord that the Rangers Command Battalion had dug in on the world of Nockatunga and were holding a priceless collection of 23rd-century Demmings crystal. Colonel Waco challenged the Irregulars to a direct fight for the rare artifacts. If they refused the challenge, he would destroy the crystal. In his words, "Any friend of the Dragoons is an enemy of mine."

Cranston led his battalion to the system, but only after careful planning. His sources told him that the entire Waco Rangers Regiment had dug in on Nockatunga in ambush. While Cranston enjoyed a duel as much as the next Clansman, he did not relish the thought of leading his troops to certain doom.

His plan was to smuggle the Irregulars down to Nockatunga in commercial DropShips hijacked from the Free Worlds League. Once on-planet, the Irregulars' infantry would quietly secure the priceless crystal collection. On the infantry's signal, the empty Irregulars' DropShips would descend on the other side of the world, springing the Rangers' trap while the Irregulars made good their getaway.

The plan worked perfectly until a Rangers light scout unit detected the Irregulars near the outskirts of the city of Thule. The Irregulars soon found themselves facing the command forces of the Waco Rangers. Using the area's steep hills as cover, Cranston surrounded the remains of Noble's Assault Company, along with Colonel Waco. Refusing to surrender, Waco led the company in an attempt to fight his way free, only to be pummeled by Cranston and his forces in a short, bloody fire fight. Cranston had the opportunity to kill Colonel Waco, but decided that a more fitting punishment would be allowing the bitter old man to live without having gained his revenge (**Fistful of Crystals and A Few Crystals More**).

Cranston called in the DropShips and left Nockatunga. He spent most of the next year refitting his forces. By early summer 3033, Snord's Irregulars were at full battalion-strength, carrying a mix of BattleMech, armor, and infantry.



## NEW IRREGULARS

*Tune in tight, you dunderheads. Until further notice, I am the acting commanding officer of this unit. I expect that we'll get in as much trouble while my father is gone as we would if he were here. Rock and roll is here to stay!*

—Rhonda Snord, 17 February 3037

In seeming contrast to his youthful energy, Cranston Snord suffered a severe heart attack in spring 3034. Later that same year, Jake Walmar, still suffering from wounds he received during the Fourth Succession War, retired from active duty to become librarian of the Irregulars' museum on Clinton. Winston Nearon also stepped down from the ranks, devoting much of his time to helping Cranston recover and to refinishing and repairing his vast collection of weaponry. The heart attack forced Snord to use a cane. His days in the cockpit of a BattleMech were slipping away. Several other original Irregulars, including Clame McDonald and John Malvinson, mustered out the following year. They were replaced by MechWarriors Rhonda recruited through her contacts in the LCAF. In keeping with the tradition her father established, Rhonda enlisted only the boldest and most interesting warriors for the ranks of the Irregulars.

Cranston and Jake both vanished briefly in early 3037, keeping their destination secret even from Rhonda. Though few ever learned of it, Cranston and Walmar had secretly crossed into the Free Worlds League on a special mission: to lay a wreath on the grave of their departed opponent, Janos Marik. Cranston later admitted that he and Jake drank a toast in Janos' tomb, brandy Cranston had stolen from the Marik world of Nestor. It was an odd gesture, clearly risky and gaining them nothing. But Cranston insisted that he owed Janos Marik at the very least a dozen

flowers for the enjoyable aggravation he had provided over the years.

Following the Fourth Succession War, Cranston gradually became more involved with his reading and intelligence-gathering than with the day-to-day operation of the Irregulars. Rhonda Snord began running the combat command, while Cranston dedicated himself to administrative details.

Only on rare occasions did he pilot a BattleMech, preferring to spend most of his time enjoying the museum and library that his unit had created. He replaced Rhonda as unit recruiter, spending several weeks each year on Solaris scouting the best that he could afford for his unit. He also recruited from the Irregulars' families on Clinton, providing a 'Mech to any second-generation Irregular who could prove his or her worth in one.

Rhonda had her first opportunity to run all aspects of Snord's Irregulars during her father's absence in 3037. When ComStar armed itself, she realized that she might be able to turn that activity to her advantage. She proposed, in a communique to Jaime Wolf, a way to introduce to the Inner Sphere the Star League BattleMechs and vehicles that the Irregulars had recovered on Phecda and Volders. Jaime approved her plan, impressed with its creativity and pleased with the opportunity to infuriate ComStar's ever-probing ROM agents.

Her plan was to deceive the Inner Sphere into believing the Irregulars had stolen a cache of ComStar BattleMechs. She ordered the vehicles and 'Mechs painted ComStar white, complete with insignia markings for the ComStar units positioned at the other end of the Inner Sphere, near the Taurian Concordat. Camouflage colors covered the ComStar markings, but not so thickly that the ComStar insignia did not show through. By using her own contacts and those of Wolfnet, she spread the word that the Irregulars had secretly defeated a ComStar unit and captured its BattleMechs and other equipment.



## WAR OF 3039 AND LATER

By the outbreak of the War of 3039, Snord's Irregulars had grown to a full battalion, outfitted with Star League equipment. Rumors raced through the Inner Sphere of how Snord's Irregulars had stolen the BattleMechs from ComStar. One account even suggested that Rhonda had personally led a group to Terra and had taken the 'Mechs from Sandhurst Academy. Cranston was overjoyed at his daughter's success, and the fine unit they had created together.

The War of 3039 allowed the newly outfitted Irregulars to test their equipment and abilities. During the invasion of Vega, the Irregulars were given several opportunities to exercise their skills in combat. Their unorthodox tactics and superior weapons stunned the traditionally trained Kurita officers they opposed. One Combine officer, *Tai-sa* Fengo Olesko, considered it an honor to fight against the unit, but disliked Rhonda's tactic of broadcasting constant, loud "music" over the communication channels.

Several casualties in the ranks during that year included the loss of Solomon Storm during the Combine counteroffensive to regain Vega. The end of the conflict found the battalion ready to return to garrison duty on Clinton (**Everything Old Is New and Storm's End**).

A funeral for Katrina Steiner was held on 8 January 3040. Cranston was present at the ceremony along with Morgan Kell and several other mercenary leaders in the employment of the Federated Commonwealth. Kell had made special arrangements for the leaders of Katrina Steiner's favorite mercenary units to pay their last respects to their former employer. Melissa Steiner Davion also attended the private ceremony vowing to fulfill her mother's wish that the units remain in the service of the still-young Federated Commonwealth. Over the next decade the Irregulars made a yearly journey for training on Outreach, the new home of Wolf's Dragoons. This added fuel to the long-standing rumors of Cranston's association with the unit, but Jaime Wolf publicly treated Snord as if his unit were amateurs compared to the Dragoons.

In 3050 Wolfnet came alive with reports of a mysterious invading force attacking from the Periphery. Fielding superior BattleMechs and technology, it appeared that the Clans had finally arrived. Rhonda and her father studied the reports, and intensified the Irregulars' training. Kerensky's heirs were fulfilling his promise.

## INVASION OF THE CLANS

—From a Wolfnet transcript of a conversation between Jaime Wolf, Rhonda Snord, and Cranston Snord, following confirmation of the return of the Clans.

JAIME WOLF: "Cranston, Rhonda, we've known each other for years. In the past you and your Irregulars have supported and followed me. I have to know now, where do you stand? Do you side with the remaining Dragoons, or with our kin in Clan Wolf?"

RHONDA SNORD: "Colonel Wolf, sir, with all due respect, the Irregulars will stand behind the Federated Commonwealth and the rest of the Inner Sphere. Among other things, the problem with the Clans is that they just don't have a sense of humor. Frankly, we think it's time we gave them something to wonder about...and something to fear. I can't wait to hear them squeal when I play "Shake, Rattle, and Roll" over the comm..."

CRANSTON SNORD: "Besides, they kicked us out over 40 years ago. They treated us freebirths like their trash. It's time that we taught them not to kick a good dog. You can count on my support of the Federated Commonwealth. If they want to forge a new Star League, they'll have to kill us first. Their ways would wipe out all the Inner Sphere. This time the freebirths will teach *them* a lesson in what being a warrior really means."

Within two weeks of the Clans' first verified contact with the Inner Sphere, Jaime Wolf met with Cranston and Rhonda to discuss whether the Dragoons and the Irregulars would help protect the Inner Sphere or fulfill their mission. He personally conveyed to them the recall order issued by the Grand Council of the Clans. Both Cranston and Rhonda refused to acknowledge the order, claiming more loyalty to the Inner Sphere than to their heritage in the Clan. The location of lost Star League facilities and other information Snord had uncovered in the past 40 years was communicated across Wolfnet, and many of the old bunkers and complexes were refitted and revitalized by Dragoon operatives for use in the upcoming war.

As the weeks passed, it became painfully clear that the Clans would continue their push deep into the Federated Commonwealth, Rasalhague, and the Draconis Combine, riding on a wave of death and destruction. As the Jade Falcons pressed forward into the Commonwealth, the front line approached the Dark Nebula.

A Star League naval base had for centuries been rumored to be hidden in the Dark Nebula. Cranston and Jake Walmar had found several references to such a base, but had never uncovered coordinates for the rumored facility. As Cranston continued to study the maps, he realized that if the facility existed, it would offer an excellent base for a counterattack against the flank of the Clan's offensive. Cranston and Jake traveled to the libraries on Derf and Wotan, known for their archives of Star League atlases and star charts. Although they did not locate the coordinates for the base, they did learn that the SLDF had set up a special astronomical survey station on the northern continent of the planet Apollo.

Further research showed no record of this facility having been sacked or looted during the Succession Wars. Cranston and Jake both realized that if the station on Apollo could be found, and if its records were intact, those records were their best chance of determining the coordinates of the Dark Nebula base. By mid-3051 Rhonda Snord had presented her mission plans to the Federated Commonwealth High Command, as well as submitting a copy of the plans through Wolfnet to Colonel Wolf. Rhonda proposed a two-part plan. The first element consisted of a raid on Apollo to locate and secure the astronomical survey station. If this was accomplished and the coordinates of the Dark Nebula base discovered, the Irregulars would jump into the Dark Nebula to where the naval base was located, determine its condition and level of functional equipment, and send their JumpShip back to the Federated Commonwealth with the coordinates. Snord's Irregulars were to hold the station until reinforcements arrived.

Given the numerous small raids being conducted against Clan-held worlds, it was believed that the Irregulars' mission stood a good chance of success. Their real intent would be covered by the fact that their actions would be considered predictable. They were given the go-ahead.

However, Apollo was held by Clan Jade Falcon and would not be lightly defended. It served as a way station between the

Periphery and the front lines of the Clan offensive. By summer 3051 troop movements between the Clan units were common, and Apollo was indeed a nexus in the Jade Falcon defense. However, Commonwealth intelligence-gathering on Clan-held worlds was weak, and there was no way for Snord's Irregulars to know what kind of reception they faced.

On 2 July 3051, the DropShips *Eagle's Bane*, *Junk Yard II*, and *Scavenger* were loaded with the Irregulars and attached to the JumpShip *Harrier*. Cranston bid his daughter and the rest of his unit farewell and the small ship jumped, arriving within three weeks at a pirate point on the far side of Apollo's largest moon. All three DropShips immediately began their descent on Apollo, executing long-range scans of the northern continent's forests where the survey station reportedly was located. The landings went undisturbed except for casual reconnaissance flights by Jade Falcon AeroSpace fighters.

Rhonda was uneasy about the lack of resistance encountered, but did not hesitate. She dispersed her forces on a search of the forest with strict orders not to engage or communicate with the enemy unless she gave specific orders to do so. After three days of searching in the dense forest, the ruins of the astronomical outpost were found, covered with a thick mesh of heavy vines and undergrowth. The Irregulars' infantry carefully made their way into what remained of the structure, and began to remove the chips and sealed charts hidden there.

Suddenly the Recon Lance of the Second Company encountered the first Clan unit to arrive in the isolated region just 250 meters from the ruined outpost. As per their orders, the Irregulars pulled back until Rhonda arrived. She requested from the Jade Falcons their unit and strength. The Falcon leader was caught off-balance by her knowledge of their ways, but quickly followed their code by announcing that they were of the Dark Wing Cluster, Trinary Alpha, Medium Star. This star of OmniMechs was the

scouting force for the Dark Wing Cluster, sent to locate and engage the Irregulars. Thinking quickly, Rhonda demanded the Falcons grant her the rite of a Trial of Possession.

Still shocked by her knowledge, but looking forward to an honorable contest, the Falcon star agreed to the trial. Rhonda led just four other BattleMechs against the clansmen. Her Command Company and most of the other Irregulars did not understand, but reluctantly followed her orders. She briefly explained that they were going to duel for the rights to the station's salvage.

The battle was brisk and fierce, pitting the Star League 'Mechs of the Irregulars against the advanced technology of the Jade Falcons. Rhonda turned the dry forest into a weapon against her kinsmen, setting fire to the heavy brush. The Clan OmniMechs usually were not concerned with heat problems, but suddenly found their heat registers climbing precipitously. Despite sustaining some damage, the Irregulars quickly crippled all the Jade Falcon OmniMechs. The Jade Falcons offered their surrender, and Rhonda accepted. When they asked for the name of the Clan that had defeated them, she created a heritage that would continue for many years. She announced they were bondsmen to Clan Snord (**Warrior's Challenge**!).

The Irregulars beat a hasty retreat to their DropShips, only to be ambushed in a forest clearing by more Jade Falcons. Fighting erupted before a challenge could be issued, and it was a hotly contested battle. Losses this time were much higher for the Irregulars, its armored vehicles bearing the brunt of the damage. Cut off from her DropShips, Rhonda ordered them diverted to a secondary landing zone, only to be cut off again by light OmniMechs and the armored Elementals of the Jade Falcons, who now began to swarm into the forest in search of combat glory. Short but fierce fire fights proved to be the norm for most of the battles (**Grand Melee**).

Rhonda ordered her troops to clear off an impromptu landing zone in a lightly forested area. Under a hail of fire from the Jade Falcon OmniMechs, Snord's Irregulars escaped from Apollo with most of the documents and maps from the old astronomical outpost. During the return flight, Jake Walmar, who had accompanied the mission aboard the *Scavenger*, scanned the material they had seized. He was able to determine that some sort of an outpost did exist in the Dark Nebula. More importantly, he found a set of coordinates. But Jake feared that some of the data as well as many of the maps that had been left behind in the fighting on Apollo would give the Falcons some indication of where they might be heading. As two stars of Clan Jade Falcon AeroSpace fighters converged on the JumpShip, it leaped into the Dark Nebula, the Irregulars hoping they had successfully evaded the Clan forces.

## CAMELOT COMMAND

As Rhonda Snord leaned over the reconnaissance tech's shoulder, the *Harrier* arrived in a small system. A Red Dwarf star, eerily shrouded in a haze of flowing stellar dust, provided dim light. The tech located a small, rotating planetoid with only a scant atmosphere clinging to its surface. Magnifying a visual scan, Rhonda saw it was black and pitted with the scars of time. Stark white lines of concrete etched its surface. Aged turrets poked up from the surface. On its eastern horizon she saw a massive port, large enough to dry-dock one of the Clan's old *Black Lion* Class Battleships. As the *Harrier* approached, she recognized a 100-meter-long Cameron Star painted on the concrete equator.

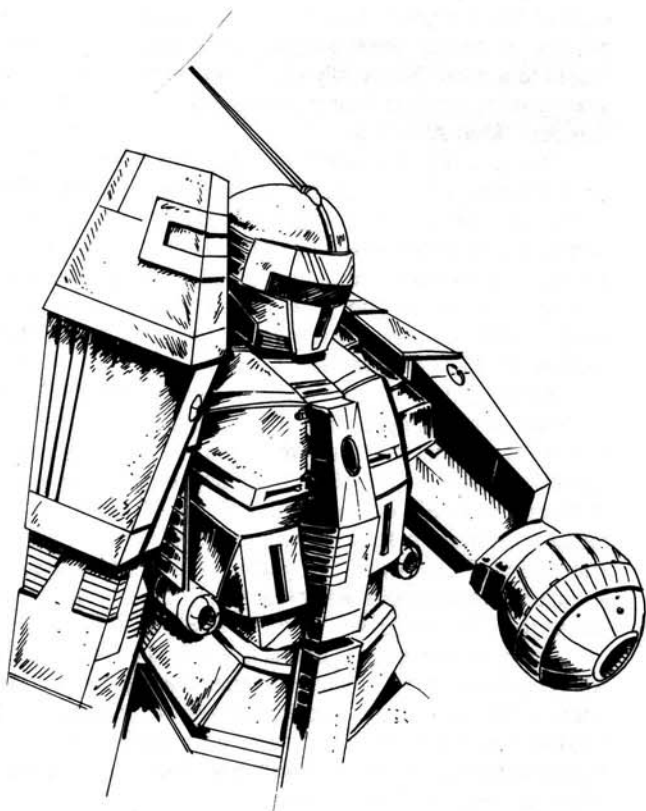



Jake Walmar descended the bridge ladder like a 20-year-old. His face was gleaming and a grin ran from ear to ear. "You won't believe this. We're being hailed by an old automatic marker buoy. It's transmitting SLDF codes. It's called Camelot Command. Rhonda, that base down there is welcoming us! After three centuries, it's giving us landing coordinates!"

Rhonda considered the dormant naval base for a long moment, then replied, "Paydirt." With a cool gaze and a dangerous grin, she pulled out an antique laser audio disk and triggered a comm switch. "Irregulars...mount up!"

The old base known as Camelot Command was deserted just before the Exodus. Stripped and abandoned, almost all records of the facility were destroyed because it was in such a volatile location along the old Commonwealth/Combine border. During the Star League's reign, the naval base had probably been used for capital ship repairs, refitting, and supply during offenses against the Rim Worlds Republic. Now it was a ghost hulk hanging in the dim light of its failing star.

Three days after their arrival, Rhonda had determined that the Irregulars could survive indefinitely on the lost outpost. The *Harrier* departed for the Federated Commonwealth to report their discovery. As expected, Camelot Command was in rough shape. Fortunately, its atmosphere recirculation system was still operational. A large manufacturing area had apparently had been used for BattleMech repair, but most of it had been poorly mothballed and much of the equipment was in shambles. Some of the outer levels were flooded, while others were holed and in near-vacuum. The warehouse facilities were impressive, with large airlocks to the battered landing strip on the surface of the planetoid. The Irregulars discovered ammunition and spare parts, but most had deteriorated to uselessness. Deep in Camelot's core near the command post, an exploration team discovered the skeletons of those who had remained behind. For them the Exodus had spelled a lonely death.

Shorty Sneed determined that it would take the Federated Commonwealth over a year to prepare the base for logistical operations. In two years Camelot could once again repair damaged ships and 'Mechs. Although these estimates were discouragingly long, they were short compared to how long it would take the Federated Commonwealth to build such a facility from scratch. Its capabilities made it vital to the survival of the Inner Sphere.

Rhonda had Shorty and the other technicians concentrate on making the outer laser turrets operational. Rhonda confided in Jake that she feared pursuit by the Jade Falcons. Isolated in this remote system, the Irregulars would be in a difficult situation if the Falcons appeared. Rhonda even transferred her armored ground forces into the sealed warehouses for possible defense. Her infantry, with the exception of a handful skilled in zero-G combat, were pulled into Camelot's interior, along with most of the supplies and other equipment the Irregulars had managed to salvage.

During these preparations, Rhonda gathered the Irregulars in the old Combat Information Center of Camelot. There she informed them of her true origins and from where the Clans had come. She made only fleeting reference to her father's association with Wolf's Dragoons. She turned her disclosure into a morale-boosting session, gathering her troops behind her unique cause against the Clans.

Five days after the *Harrier* left, Rhonda's worst fear was realized. An *Aegis* Class Cruiser appeared at the jump point, emblazoned with the green bird of the Jade Falcons. Rhonda knew that the Irregulars were in for a tight and dangerous battle,

with little hope of timely relief. Two large DropShips approached the planetoid. The ships radioed a challenge for combat, a call from the Jade Falcons to the defender of Camelot. It was a challenge that Rhonda Snord could not ignore, no matter how much she wished she could. Rhonda knew that if Camelot fell to the Jade Falcons, it could turn all of Chahar Province into a battle zone.

The internal bidding by the Falcons command took several long minutes, which Rhonda and her forces used to prepare themselves. She could not commit all her units at once. Her overall strategy was to slowly and methodically wear down the Falcon attackers, luring them into situations where her own Star League BattleMechs and equipment could best be brought to bear. She used her light and medium BattleMechs and the few functioning turrets to blunt the initial attack. In the low surface gravity, movement speeds were dramatically increased, evening the odds, since neither force had much experience in combat under such conditions.

As the battle erupted, decompression hits toppled the fast-moving 'Mechs on both sides. In the thin surface atmosphere, a single shot could spell the end for any BattleMech. Elementals found themselves seriously hurt when their armor was pierced by shots that normally caused little damage. After the opening wave of attack, the Irregulars were forced to withdraw into the warehouses, and the Jade Falcons had lost a large number of their heavy OmniMechs (**Camelot's Gate**).

In the pressurized environment of the enormous warehouse and factory facilities, a more traditional battle broke out when the Falcons forced their way inside the base. The Irregulars made good use of their deployment and defenses. However, the Jade Falcon Elementals, no longer threatened with explosive decompression, proved more agile and deadly in the tight quarters, inflicting serious damage (**Pitched Battle**).

As the Elementals moved toward the command post at the core of the complex, they were ambushed by the Irregulars' infantry. In bloody close combat in the halls of Camelot, they fought to a draw. Eventually each side fell back, and only scattered gunfire marked their passage through the old complex's corridors (**Men-At-Arms**).

The surviving Irregulars retreated into the large fusion reactor chamber of the outpost for a final stand. As the remaining Falcon OmniMechs charged into the room, Rhonda led a counterattack with what was left of her forces. The ferocity of her charge to point-blank range momentarily stunned the Jade Falcon warriors. When the Clan forces attempted to hold their ground, they were overwhelmed by the Irregulars' anti-Mech infantry (**Birth of a Legend**).

Bloody and beaten, Star Colonel Damon conceded victory to the Irregulars. Having lost his Trial of Possession, along with the raised bid that included his own forces in the stakes, he surrendered his remaining DropShips, troops, and all other equipment to Rhonda's newly declared Clan Snord. The Falcon Cruiser departed without a fight, having lost the trial fairly. With their knowledge of Clan ways and traditions, and their sudden accumulation of resources, it was clear that Snord's Irregulars were a power to be reckoned with in the Inner Sphere.

Cranston arrived at Camelot Command a week later, along with engineers and technicians dispatched by the Archon. The secret of the Dark Nebula had finally been revealed and the Clans had been dealt a harsh loss. It made the older Snord proud of the legacy he had founded...and left him wondering what adventures might lie ahead for Clan Snord.



# TABLE OF ORGANIZATION AND EQUIPMENT

## SNORD'S IRREGULARS 3026-3037

### FIRST (COMMAND) COMPANY

#### COMMAND LANCE

Colonel Cranston Snord (*Piloting 1, Gunnery 2*), Archer  
Lieutenant Deb H'Chu (*Piloting 2, Gunnery 1*), Thunderbolt  
David Rowsch (*Piloting 5, Gunnery 3*), Marauder  
(3026-35) John Malvinson (*Piloting 4, Gunnery 3*), Wasp  
(3035-37) Sharonus Wayne (*Piloting 3, Gunnery 4*), Clint

#### Attack Lance

Lieutenant Marcos Shake (*Piloting 3, Gunnery 1*), Catapult  
Tempest Storm (*Piloting 5, Gunnery 5*), Centurion  
Anthony Pryor (*Piloting 5, Gunnery 4*), Orion  
(3026-35) Clame McDonald (*Piloting 3, Gunnery 2*), Victor  
(3035-37) Charlotte Deblois (*Piloting 3, Gunnery 3*), Victor

#### Recon Lance

(3026-34) Lieutenant Winston Nearon (*Piloting 2, Gunnery 2*),  
Locust  
Betty Orzenchi (*Piloting 5, Gunnery 5*), Ostscout  
Cyndos Thomlinson (*Piloting 4, Gunnery 6*), Spider  
Arnold Ling (*Piloting 4, Gunnery 4*), Jenner  
(3035-37) Adrian MacLeod (*Piloting 5, Gunnery 2*), Cicada

### SECOND COMPANY (SHORTY'S SCAVEN- GERS)

#### Command Lance

Captain Samuel "Shorty" Sneeде (*Piloting 1, Gunnery 1*),  
Rifleman  
(3026-34) Lieutenant Jake Walmar (*Piloting 2, Gunnery 2*),  
Warhammer  
Marleen Danules (*Piloting 5, Gunnery 5*), Clint  
Carter Malvinson (*Piloting 6, Gunnery 5*), Phoenix Hawk  
(3034-37) Daniel Trump (*Piloting 2, Gunnery 3*), Shadow  
Hawk

#### Support Lance

Lieutenant Darrell Lanst (*Piloting 4, Gunnery 4*), Von Luckner  
Heavy Tank  
Dorchester Quinn (*Piloting 5, Gunnery 4*), Galleon Light Tank  
Archie Ferris (*Piloting 6, Gunnery 2*), Striker Light Tank  
Nathan "Beaver" Hauck (*Piloting 5, Gunnery 5*), Packrat LRP

#### Air Lance

Lieutenant Richter Nikmen (*Piloting 4, Gunnery 4*), Stuka  
Travis Horr (*Piloting 4, Gunnery 5*), Corsair  
Yolinda Brekner (*Piloting 5, Gunnery 4*), Chippewa

### THIRD COMPANY (RHONDA SNORD'S IR- REGULARS)

#### Command Lance

Captain Rhonda Snord (*Piloting 2, Gunnery 2*), Shadow Hawk  
Lieutenant Terry Malvinson (*Piloting 3, Gunnery 3*), Phoenix  
Hawk  
(3026-29) Shalimar Windall (*Piloting 2, Gunnery 2*), Crusader  
Walker Roche (*Piloting 4, Gunnery 6*), Griffin  
(3029-37) Victoria Rose (*Piloting 4, Gunnery 4*), Awesome

#### Fire Lance

Lieutenant Bright Thomlinson (*Piloting 2, Gunnery 1*), Rifleman  
Solomon Storm (*Piloting 2, Gunnery 3*), Wolverine  
Linda Thomlinson (*Piloting 6, Gunnery 3*), Scorpion  
Blade Windall (*Piloting 4, Gunnery 4*), Warhammer

#### Support Platoons

Lieutenant Fasha Nagaraj, Veteran  
Sergeant Baca Tsaprazis, Veteran, Jump Infantry (Laser)  
Sergeant Nanette Warkentin, Green, Motorized Infantry  
(SRM)  
Sergeant Roger H'Chu, Regular, Jump Infantry (SRM)  
Corporal Darwin (Breaker) Morgan, Regular, Motorized Infan-  
try (Laser)



# TABLE OF ORGANIZATION AND EQUIPMENT

## SNORD'S IRREGULARS 3037-3051

### AFTER RE-FIT TO STAR LEAGUE-ERA EQUIPMENT

#### FIRST (COMMAND) COMPANY, RHONDA SNORD'S IRREGULARS

##### Command Lance

Colonel Rhonda Snord (*Piloting 2, Gunnery 1*), *Highlander*  
Dennis Maltesta (*Piloting 2, Gunnery 2*), *Excalibur*  
David Rowsch (*Piloting 3, Gunnery 2*), *Guillotine*  
Sharonus Wayne (*Piloting 3, Gunnery 2*), *Spartan*

##### Attack Lance

Lieutenant Marcos Shake (*Piloting 2, Gunnery 1*), *Bombardier*  
Tempest Storm (*Piloting 3, Gunnery 2*), *Spartan*  
Anthony Pryor (*Piloting 3, Gunnery 1*), *Lancelot*  
Charlotte Deblois (*Piloting 3, Gunnery 1*), *Thug*

##### Recon Lance

Lieutenant Cyndos Thomlinson (*Piloting 2, Gunnery 3*),  
*Mercury*  
Adrian MacLeod (*Piloting 3, Gunnery 2*), *Hussar*  
Walker Roche (*Piloting 3, Gunnery 2*), *Champion*  
Arnold Ling (*Piloting 3, Gunnery 1*), *Kintaro*

#### SECOND COMPANY (SHORTY'S SCAVEN- GERS)

##### Command Lance

Captain Samuel "Shorty" Sneede (*Piloting 1, Gunnery 1*),  
*Crockett*  
Daniel Trump (*Piloting 2, Gunnery 2*), *Champion*  
Marleen Danules (*Piloting 4, Gunnery 2*), *Crab*  
Carter Malvinson (*Piloting 4, Gunnery 3*), *Black Knight*

##### Support Lance

Lieutenant Darrell Lanst (*Piloting 3, Gunnery 3*), *Padilla Artil-  
lery Tank*  
Dorchester Quinn (*Piloting 4, Gunnery 2*), *Burke Heavy Tank*  
Archie Ferris (*Piloting 4, Gunnery 1*), *Demon Armored Car*  
Nathan "Beaver" Hauck (*Piloting 2, Gunnery 3*), *Rotunda  
Scout Car*

##### Air Lance

Lieutenant Richter Nikmen (*Piloting 3, Gunnery 2*), *Rapier*  
Travis Horr (*Piloting 3, Gunnery 3*), *Ironsides*  
Yolinda Brekner (*Piloting 4, Gunnery 2*), *Gotha*

#### THIRD COMPANY

##### Command Lance

Captain Deb H'Chu (*Piloting 1, Gunnery 1*), *Exterminator*  
Lieutenant Terry Malvinson (*Piloting 2, Gunnery 1*), *Lancelot*  
Victoria Rose (*Piloting 3, Gunnery 2*), *Excalibur*  
Richard "Rickbo" Burkeman (*Piloting 3, Gunnery 1*), *Champion*

##### Fire Lance

Lieutenant Bright Thomlinson (*Piloting 2, Gunnery 1*),  
*Crockett*  
(3037-39) Solomon Storm (*Piloting 2, Gunnery 2*), *Sentinel*  
Linda Thomlinson (*Piloting 4, Gunnery 1*), *Flashman*  
Blade Windall (*Piloting 1, Gunnery 2*), *Highlander*  
(3039-51) Dalid "Darkside" Burns (*Piloting 5, Gunnery 3*),  
*Enforcer*

##### Support Platoons (Anti-Mech Trained)

Lieutenant Fasha Nagaraj, *Elite*  
Sergeant Baca Tsaprazis, *Veteran, Jump Infantry (Laser)*  
Sergeant Nanette Warkentin, *Regular, Motorized Infantry  
(SRM)*  
Sergeant Roger H'Chu, *Veteran, Foot Infantry (SRM)*  
Corporal Darwin "Breaker" Morgan, *Elite, Motorized Infantry  
(Laser)*





**COMMAND  
COMPANY  
PERSONNEL,  
3050**

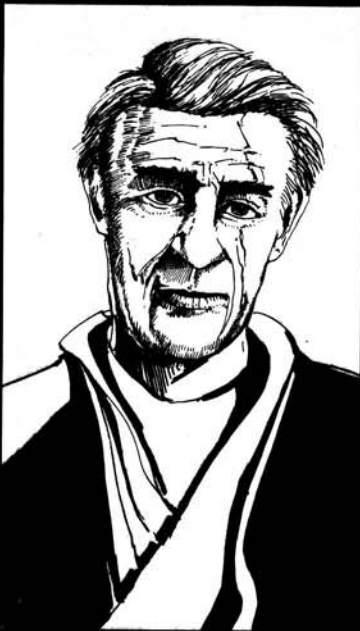



**Age:** 76

**Home Planet:** Grant's Station (Clan space)

**'Mech Type:** Archer (3026-3037)/Bombardier (3037-)

**'Mech Status:** Excellent

Throughout his career, Cranston Snord has proven to be one of the Inner Sphere's most capable and unpredictable mercenary commanders. Since his contrived departure from Wolf's Dragoons, Cranston has built and maintained an elite mercenary unit capable of withstanding whatever future exists after the arrival of the Clans. Even today, Snord is known for his youthful attitudes and enthusiasms. However, much of this is a cover for a very logical mind. His logic is carefully balanced with his reputation as an eccentric looter and collector of the relics of the past.

His heart attack several years ago left him with nerve damage in his left leg, forcing him to use a cane. (Note that the cane itself is rumored to be made of hickory and to have belonged to President Andrew Jackson of Terra's United States.) Only on rare occasions does he pilot a 'Mech today, and never in combat exercises. Despite his age, Cranston is still a popular and striking figure. He wears an old SLDF dress uniform and carries one of his antique pipes, though Rhonda no longer allows him to smoke them.

Although many commanders his age have retired, Cranston has maintained his involvement with the Irregulars. Rhonda handles all combat operations, while he oversees financing, contracts, and recruitment. With the recent victory over the Jade Falcons at Camelot Command, Cranston has assumed the responsibility for integrating the Falcon bondsmen into the Irregulars and for refitting their OmniMechs and other equipment.

Cranston Snord envisions the Irregulars reaching regimental size in the coming months, staffed by captured Clansmen sworn to Clan Snord. With his knowledge of Clan Warriors, his dream is a distinct possibility.



**Warrior Data:**

BOD - 8  
DEX - 4  
LRN - 11  
CHA - 8  
PIB - 7  
HTK - 80

Total XP: 256,000  
XP Available: 12,900

**Equipment:**

Sunbeam Laser Pistol  
Vibro-Blade

**Notes:**

Sixth Sense  
Natural Right, but uses left.  
Coordinates contracts and missions of Snord's Irregulars.  
Has extensive knowledge of Clans, especially Clan Wolf.

**Known Skills:**

	Skill Level	Attribute Target	Modified Skill Roll Target
Diplomacy	6	8	2
Gunnery/'Mech	6	10	4
Leadership	6	8	2
Piloting/'Mech	7	8	1
Pistol	5	10	5
Streetwise	6	8	2
Survival	5	8	3
Tactics	6	7	1
Technician	4	7	3

**Age:** 51

**Home Planet:** Grant's Station (Clan Space)

**'Mech Type:** *Highlander*

**'Mech Status:** Excellent. The words "Heavy Metal" painted on the Gauss rifle barrel; several external speakers mounted to broadcast music.

Rhonda is the only child of Cranston Snord. She was born a freebirth in Clan Space just before her father earned his rank in the Warrior Caste of Clan Wolf.

The loss of her mother at age three bound her even tighter to her father, an atypical bond in the Clans' highly structured society. When Cranston enlisted with Joshua and Jaime Wolf, he insisted that Rhonda, now six, accompany him. He argued that a mercenary unit would be more believable if it included a few dependents. Clan Wolf was less concerned with believability than with getting rid of Cranston; they agreed to his demand.

Training as a MechWarrior was hard to avoid while Rhonda was growing up. She was readily accepted as an equal by the other Irregulars as soon as she was of age to pilot a 'Mech. Unfortunately, during her first heavy combat, on Phecda, she was terribly wounded, losing most of her right leg and all of her left. If not for medical services provided covertly by Wolf's Dragoons, Rhonda would never have piloted a BattleMech again.

Rhonda developed a strong taste for music, particularly that of the 20th-century rock and roll era. Her particular love is Elvis Presley, but in recent years she has recognized the disruptive value of heavy metal music broadcast loudly from the external speakers on her *Highlander* during battle.

Like her father, Rhonda hides a methodical and logical mind under her outward eccentricity. She has a complete understanding of Clan traditions and incorporates some of their discipline into her current leadership style. Rhonda is torn between her true heritage and her love for the Inner Sphere and its rich history. After years of inner conflict, she has finally cast her lot with the Inner Sphere.

Rhonda secretly adopted a child twelve years ago, naming the young girl Alexandria Natasha Snord. The child was orphaned during a Free Worlds League raid and is being raised on Clinton. Alexandria's godmother, Misha Auburn, is the only non-Irregular who is aware of the relationship between Rhonda and her adoptive daughter.



**Warrior Data:**

BOD - 6  
DEX - 9  
LRN - 8  
CHA - 8  
PIB - 7  
HTK - 60

Total xp: 167,900  
xp Available: 7,500

**Equipment:**

Star League Sonic Stunner

**Notes:**

Collects old music, favoring early-era rock and roll.  
Has two bionic leg replacements.

**Known Skills:**

	Skill Level	Attribute Target	Modified Skill Roll Target
Bow/Blade	2	8	6
Brawling	3	9	6
Diplomacy	5	8	3
Gunnery/ Mech	7	8	1
Leadership	5	8	3
Medical/First Aid	4	8	4
Piloting/ Mech	6	8	2
Pistol	4	8	4
Rogue	4		
Bribery	2	8	6
Disguise	1	8	7
Forgery	1	8	7
Hide In Cover	2	8	6
Listen/Eavesdrop	3	8	5
Security Systems	4	8	4
Stealth	3	8	5
Survival	3	8	5
Tactics	5	8	3

# CHARLOTTE DEBLOIS 18

**Age:** 36

**Home Planet:** Carver V

**'Mech Type:** *Thug*

**'Mech Status:** Good. It has a great deal of apparent damage, with battered and beaten armored plates. In reality the 'Mech is in fine trim; this simulated damage is to lull her enemies into overconfidence.

With short, cropped hair bleached white, Charlotte Deblois accomplishes the difficult: she is perceived as a rebel within the ranks of the Irregulars. She is loud and rude and speaks with a distinctive nasal twang that she ascribes to her childhood on Carver V, in the Tikonov Republic. The uncharitable suspect that she has adopted it just to be irritating.

Her family, with the exception of a younger brother, was wiped out during House Marik's struggles against revolutionaries on Carver V. She and her brother fled with a handful of other guerrillas when Marik troops captured and executed her family as traitors.

During her involvement in the resistance movement on Carver V, Charlotte learned to pilot a captured, marginally operational *Victor*. Her skill with the battle-worn 'Mech earned her a modest reputation. When she learned in 3035 that Clame McDonald had retired from the Irregulars, she bought transportation to Clinton and demanded an opportunity to join Snord's Irregulars.

Cranston was initially reluctant to accept the abrasive young woman into his ranks. She had chosen the Irregulars because she was filled with rage against House Marik and knew they frequently clashed. She hoped to gain revenge in battle for her family's death. Snord was afraid she would become irrational and dangerous if attacked by Marik forces. However, he gave her McDonald's slot on a trial basis, and she has been an Irregular ever since. Her actions on Vega during the War of 3039 have enhanced her reputation.

Charlotte has been approached several times by ROM agents attempting to penetrate the close ranks of the Irregulars. Each time she has played along with her presumed seducers, but they have yet to learn anything of importance from her. Apparently ComStar sees her as a weak link in the Irregulars' otherwise tight chain. After the third such attempt, she added ComStar to House Marik as future targets.



#### Warrior Data:

BOD - 9

DEX - 9

LRN - 9

CHA - 8

PIB - 6

HTK - 90

Total XP: 89,000

XP Available: 7,900

#### Equipment:

Mauser and Gray Needler Pistol

#### Contacts:

Several diplomatic couriers in the Federated Commonwealth  
Savalis, a ComStar technician

#### Known Skills:

	Skill Level	Attribute Target	Modified Skill Roll Target
Brawling	7	8	1
Gunnery/'Mech	7	8	1
Piloting/'Mech	5	8	3
Pistol	3	8	5
Rifle	4	8	4
Survival	2	8	6
Tactics	5	8	3



**Age:** 50

**Home Planet:** Arc-Royal

**'Mech Type:** *Kintaro*

**'Mech Status:** Excellent. Its front is painted to look like the front of a 19th-century steam locomotive.

Arnold Ling has been fascinated with toys, especially model railroads, since childhood. His father was a moderately wealthy landowner who provided Arnold with whatever toys he could afford. Arnold soon became a collector. His collection is large, and most of the pieces pre-date the Star League.

Arnold graduated from the War College of Tamar at the top of his class. After a short stint with the Twenty-Sixth Lyran Guards, he resigned his commission to serve with Snord's Irregulars. Cranston was impressed by his skills and by the toy collection that Ling offered to the Irregulars' Clinton museum.

Like many of the Irregulars, Arnold is not motivated by rank, but by the opportunity to expand his collection. Using his wages and family funds, Arnold has created the only running HO-scale railroads within the Inner Sphere. They are set up in the Irregulars' museum and in numerous traveling exhibits throughout the Federated Commonwealth. The exhibits' popularity with children has made Ling a hero and created goodwill for the Irregulars wherever they have been exhibited.

Arnold has excelled as a MechWarrior. He was severely wounded in the Fourth Succession War raid on Connaught, when his *Jenner* squared off against two Marik *Shadow Hawks*. He jumped on one of his opponents, but the other *Shadow Hawk* tore off one of his legs and used it as a club, nearly crushing him in the cockpit. In the fight he lost his left hand, which was replaced with a bionic one.

During action in the War of 3039 on Vega, Arnold, in his new *Kintaro*, proved adept at ferreting out the enemy and striking at their rear. He has difficulty thinking through some combat situations, and still lacks the patience that Rhonda feels he needs. While he is sometimes slow in his response to authority, Lieutenant Thomlinson has found Ling to be quick-thinking and accurate, both useful qualities in a mobile Recon Lance.

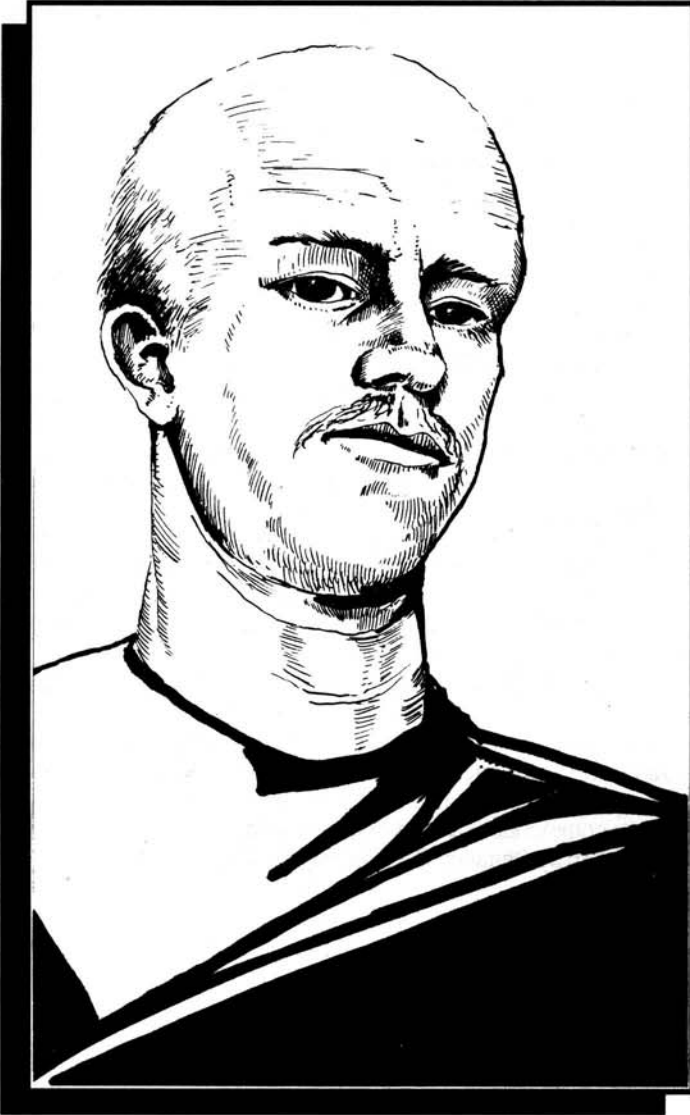

**Warrior Data:**

BOD - 6  
 DEX - 7  
 LRN - 9  
 CHA - 7  
 PIB - 7  
 HTK - 60  
 Total XP: 90,000  
 XP Available: 1,300

**Equipment:**

Star League Sonic Stunner

**Contacts:**

Two ComStar Adepts

**Notes:**

Collects antique toys.  
 Left hand is bionic.

**Known Skills:**

	Skill Level	Attribute Target	Modified Skill Roll Target
Bow/Blade	2	8	6
Computer	3	8	5
Gunnery/ Mech	7	8	1
Piloting/ Mech	5	8	3
Rifle	5	8	3
Rogue	2		
Bribery	2	8	6
Forgery	2	8	6
Listen/Eavesdrop	2	8	6
Security Systems	2	8	6
Survival	2	9	7
Tactics	7	8	1

**Age:** 39  
**Home Planet:** Procyon  
**'Mech Type:** Hussar  
**'Mech Status:** Excellent

Adrian MacLeod is something of a loner within the Irregulars. She is shorter than any other MechWarrior in the unit and is secretive about her past. She has an insignia tattoo from Wolf's Dragoons on her upper right arm, but refuses to discuss her life before the Irregulars.

In reality, Jaime Wolf mustered her out of the Dragoons in 3033 for insubordination. Usually such a skilled warrior would find a place with the Black Widows, but no positions were available. Instead, Wolf asked Rhonda if she could make use of her, and Adrian was offered a position in the Irregulars, filling the gap left by Winston Nearon's retirement. Jaime Wolf has definitely stated that she is not a Clan Warrior, hinting that he knows her past, but neither Cranston nor Rhonda have inquired further.

Adrian is deadly to the point of recklessness during a fight. While her piloting and gunnery abilities are above average, she lacks patience and tends to rush into a fight without fully evaluating the situation. As Rhonda has told her, "What distinguishes a good MechWarrior is not knowing how to fight, but knowing when to fight."

Assigned originally to a *Cicada*, Adrian was less than impressed with her new *Hussar* BattleMech. Cranston and Rhonda decided that providing her with less firepower might help her resist her thirst for combat. With only one primary weapon, Adrian must first think about how she plans to use it.

Her only known form of relaxation is the bagpipe. The pipes she plays bears the insignia of the Northwind Highlanders, but she refuses to discuss how she came into possession of them. At least twice she has broadcast a recorded chip of the bagpipes over the communications channels while entering combat. Although her lance commander Cyndos Thomlinson disapproves, the action is smiled on by Battalion Commander Rhonda Snord, who favors a similar tactic.



**Warrior Data:**

BOD - 9  
 DEX - 7  
 LRN - 10  
 CHA - 7  
 PIB - 7  
 HTK - 90  
 Total XP: 110,000  
 XP Available: 8,000

**Equipment:**

Mauser 960 Assault System

**Contacts:**

Three members of Wolf's Dragoons  
 Two officers in the Northwind Highlanders

**Notes:**

Plays the bagpipe.

**Known Skills:**

	Skill Level	Attribute Target	Modified Skill Roll Target
Brawling	7	8	1
Diplomacy	2	8	6
Engineering	2	7	5
Gunnery/Mech	6	8	2
Piloting/Mech	5	8	3
Pistol	3	8	5
Rifle	2	8	6
Rogue	5		
Bribery	5	8	3
Disguise	2	8	6
Forgery	4	8	4
Hide In Cover	3	8	5
Listen/Eavesdrop	5	8	3
Stealth	1	8	7
Survival	2	8	6
Tactics	6	7	1

# DENNIS MALTESTA 21

**Age:** 36

**Home Planet:** Palos

**'Mech Type:** *Excalibur*

**'Mech Status:** Excellent. It has a large red diamond painted on the center torso with the Irregulars' logo in the center of the gem shape.

A graduate of the New Avalon Military Academy, Dennis served three years with the Third Crucis Lancers RCT where he distinguished himself as a MechWarrior. However, Dennis had a fondness for moonlighting, primarily in the pursuit of jewelry. Specifically, he had a knack for acquiring priceless pieces that did not legally belong to him.

When apprehended, he was given two choices: face full court martial for his cat-burglary, or muster out with a dishonorable discharge. Dennis chose the second option and found himself without employment and carrying a marked military record. This made him a prime candidate for recruitment by Cranston Snord.

Dennis joined Snord's Irregulars in late 3037 and was almost immediately assigned to the Command Lance. Cranston was impressed with his potential, and gave him room for swift improvement if he proved capable. In addition, Dennis has had several opportunities to put his clandestine skills to work, and he now has a place in the Irregulars' museum to exhibit his collection of fine jewelry.

Federated Commonwealth military officials frown on his "hobby" and warn local constables when the Irregulars are posted to garrison duty on a new world. The Irregulars' museum on Clinton is an increasingly popular location with authorities to begin a search for stolen gems and jewelry.

Thus far Dennis has managed to stay one step ahead of the law.



**Warrior Data:**

BOD - 6

DEX - 7

LRN - 8

CHA - 6

PIB - 5

HTK - 60

Total XP: 100,000

XP Available: 4,000

**Equipment:**

Star League Vibro Lock Pick Kit

Star League Laser Pistol

Model 15 Gripper Gloves

**Notes:**

Collects rare gemstones

**Known Skills:**

	Skill Level	Attribute Target	Modified Skill Roll Target
Brawling	5	9	4
Gunnery/Mech	6	8	2
Piloting/Mech	6	8	2
Pistol	2	8	6
Rogue	6		
Forgery	5	8	3
Hide In Cover	5	8	3
Listen/Eavesdrop	2	8	6
Security Systems	6	8	1
Stealth	6	8	2
Streetwise	6	9	3
Tactics	5	8	3



**Age:** 47

**Home Planet:** Koniz

**'Mech Type:** *Lancelot*

**'Mech Status:** Excellent. It is painted in traditional Star League Defense Force camo patterns, with the logo for the 146th Royal BattleMech Division (the George S. Patton Division).

Those who frequent the bars of Clinton call Anthony Pryor "The Madman," a nickname that many in his own battalion believe understates the truth. He has long auburn hair, usually tied back with a white bandanna marked with Team Banzai's logo, even though he has never served with the unit. He wears glasses from time to time, and is known both for his heavy drinking and powerful fighting abilities.

Anthony was recruited to join the Irregulars in November 3026 when Cranston Snord discovered the MechWarrior at an antique shop on Tharkad. On leave from the Fourth Skye Rangers, Anthony was bartering unsuccessfully for several SLDF medals and buttons. Cranston, intrigued with the transaction, helped bring the price down. The two discussed Pryor's large collection, and the following morning he resigned his commission with the Skye Rangers for a tour of duty with Snord's Irregulars.

Anthony's love of Star League Defense Force memorabilia has developed into a passion. By the War of 3039, he had taken to wearing an SLDF lieutenant's uniform acquired by the Irregulars on Bordon. Complete with a vintage Mauser 22J laser pistol, Anthony presents the exact image of a Star League trooper.

When the new Star League BattleMechs were introduced to the Irregulars, Anthony eagerly participated in their restoration. He has since immersed himself in the technical manuals that came with the 'Mechs, and has even gone so far as to paint his BattleMech in a Star League color scheme. His *Lancelot's* colors match those of the 146th Royal BattleMech Division.

Anthony has distinguished himself in combat many times over. He has developed a strong hatred of Savannah Master hovercraft, after five of these fast-moving little vehicles crippled his *Lancelot* during action on Vega. On the left leg of his BattleMech he has painted three Savannah Master silhouettes, indicating how many of the craft he has destroyed.



**Warrior Data:**

BOD - 11  
 DEX - 10  
 LRN - 8  
 CHA - 7  
 PIB - 8  
 HTK - 110  
 Total XP: 168,000  
 XP Available: 3,400

**Equipment:**

Star League Laser Pistol  
 Model 15 Gripper Gloves

**Notes:**

Collects SLDF memorabilia

**Known Skills:**

	Skill Level	Attribute Target	Modified Skill Roll Target
Gunnery/Mech	6	7	1
Leadership	2	8	6
Piloting/Mech	5	8	3
Pistol	4	7	3
Tactics	6	8	2
Technician	7	8	1

**Age:** 58

**Home Planet:** Roche (Clan Space)

**'Mech Type:** *Champion*

**'Mech Status:** Excellent

Walker is one of the few Irregulars who began with Clan Wolf. During the Dragoons' first supply run back to Clan space in 3009, Walker and a handful of other replacement troops joined the Dragoons. His record as a freebirth warrior was average at best, and service with the Dragoons provided a chance for greater glory. He chose as a surname the name of the Clan Wolf world of Roche and swore to bring honor to his parents, members of the Scientist Caste.

Walker served with Wolf's Dragoons until 3026 when he officially mustered out. He had become disillusioned with the Dragoons' mission, having come to love the freedom of the Inner Sphere more than the traditions of the Clans. His contract was picked up almost immediately by Cranston Snord. Jaime Wolf told Walker of the Irregulars' true origin, and Walker saw them as a happy medium between the Clans and the Inner Sphere.

As Walker saw how both the Dragoons and the Irregulars over time were straying from their original mission, he became more devoted to Snord and the Irregulars. During his tour with the Third Company, he proved his skills both on Bordon, during the Fourth Succession War, and when he and Cyndos Thomlinson held back the Waco Rangers in their infamous attempted ambush.

Walker's greatest honor came when he was assigned a Star League *Champion* BattleMech. He spends most of his off-duty hours carefully cleaning and maintaining his prized 'Mech. When the Dragoons and Irregulars cast their lot with the Inner Sphere, Walker became more determined than ever to end the threat the Clans represent.

Walker Roche's closest friend is Shorty Sneede. Both warriors come from Clan Wolf, and both were long aware of the Irregulars' secrets. Shorty is passing on his technical skills to Walker as they spend time together in the hidden SLDF base under the Irregulars' museum on Clinton, doing light maintenance and repair work on the facility.



**Warrior Data:**

BOD - 11  
 DEX - 10  
 LRN - 9  
 CHA - 6  
 PIB - 6  
 HTK - 110  
 Total XP: 102,000  
 XP Available: 10,200

**Equipment:**

Mauser and Gray Needler Pistol

**Contacts:**

Jaime Wolf  
 Three low-level Clan Wolf contacts

**Notes:**

Walker is well-versed in Clan combat trials and traditions

**Known Skills:**

	Skill Level	Attribute Target	Modified Skill Roll Target
Athletics	5		
Acrobatics	4	7	3
Climbing	1	7	6
Equestrian	4	7	3
Running	3	7	4
Swimming	3	7	4
Gunnery/Mech	5	7	2
Leadership	2	9	7
Piloting/Mech	5	8	3
Pistol	4	7	3
Tactics	4	8	4
Technician	6	8	2

**Age:** 48

**Home Planet:** Oriente

**'Mech Type:** *Guillotine*

**'Mech Status:** Excellent. Two medium pulse lasers replace the four medium lasers.

David Rowsch's father, Scotty Rowsch, became Dispossessed during the peak of the Third Succession War while serving with the Fifth Oriente Hussars. David despaired of ever piloting a BattleMech in combat until he learned that Snord's Irregulars were looking for skilled MechWarriors, even those without BattleMechs.

Cranston tested the young pilot on Solaris and found him to have steady nerves, an edge in any fight. He offered David one of the BattleMechs recovered and refitted from Phecda. His father was infuriated at the thought of his son serving one of the Free Worlds League's most notorious enemies, and disowned David. The two never spoke again. Since the death of his father in 3031, David has considered the Irregulars his only real family.

Originally David piloted a *Marauder*, becoming proficient in its operation. During the raid on Bordon during the Fourth Succession War, his *Marauder* was trapped in a box canyon and separated from the rest of the Irregulars. Five Free Worlds League BattleMechs blasted his 'Mech into a smoldering slag pile as he valiantly battled on, refusing to surrender, until the rest of his company arrived. It took nearly an hour for Rhonda Snord to cut him free of the remnants of his cockpit.

David was hospitalized for eight months, during which time he oversaw the reconstruction of his battered *Marauder*. The restored 'Mech was plagued with problems, however, so he was delighted when Rhonda offered him an undamaged *Guillotine*.

After the dispute with his father and his beating at the hands of the House Marik 'Mechs, David is angrier than ever at the Irregulars' traditional foe, The Free Worlds League.

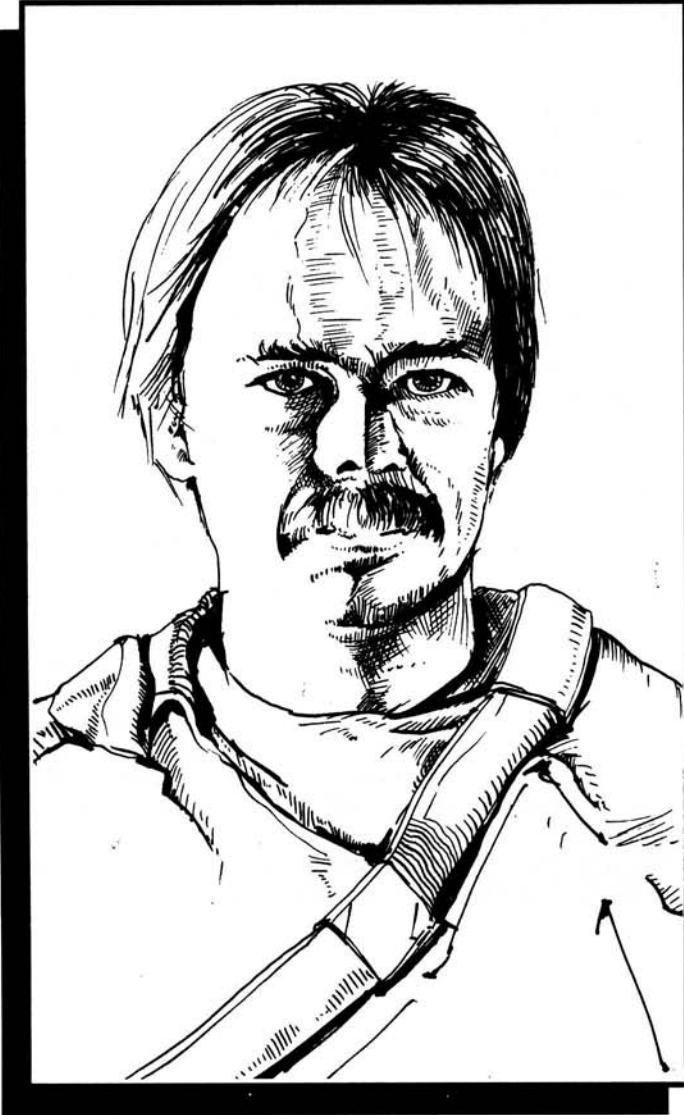

**Warrior Data:**

BOD - 7  
 DEX - 8  
 LRN - 8  
 CHA - 9  
 PIB - 1  
 HTK - 70  
 Total xp: 76,800  
 xp Available: 5,600

**Equipment:**  
 None

**Known Skills:**

	Skill Level	Attribute Target	Modified Skill Roll Target
Bow/Blade	2	8	6
Gunnery/Mech	6	8	2
Piloting/Mech	5	8	3
Pistol	6	8	2
Rifle	4	8	4
Streetwise	4	8	4
Survival	3	8	5



**Age:** 55 (approximately)

**Home Planet:** Unknown

**'Mech Type:** *Bombardier*

**'Mech Status:** Excellent. Named the "Question Mark"

Marcos is a mystery to the Irregulars and also to himself. In 3025, at the peak of the Third Succession War, the Commonwealth world of Zaniah was raided by the Free Worlds League. Most of Zaniah's capital city was looted and left burning. Snord's Irregulars were sent to relieve the city and there discovered a MechWarrior in a crimson Commonwealth *Archer* surrounded by the remains of six House Marik 'Mechs.

The *Archer* had been torn into shreds and the pilot, Lieutenant by the rank indicated on his clothing, had sustained multiple injuries and was in a deep coma. Cranston treated the MechWarrior and transferred him to Clinton when the Irregulars left Zaniah.

When he finally awoke, the man had no knowledge of who he was or how he got to Zaniah. He remembered only that his first name was Marcos and that he had been piloting a BattleMech. A check of LCAF records, including DNA samples, did not match the lieutenant with any known person in the LCAF, nor was he claimed by the Free Worlds League. His *Archer* was similarly unregistered and unclaimed.

Regardless of his previous history, the man was a highly skilled MechWarrior. He was given command of the Command Company Attack Lance in 3026. He assumed the last name of Shake, based on a nervous condition of his left arm, the results of his injuries on Zaniah.

In combat, Lieutenant Shake is a feared opponent, cold and cunning. He is a quiet fighter and has been known to play with his enemies, keeping them at extreme range and using his *Bombardier's* long-range missiles to wear them down. Once the opposing 'Mech is weakened, Marcos closes in for the kill, usually pummeling his opponent with kicks and punches.

When off-duty, Marcos uses the Clinton computer and library in an attempt to discover his identity. Almost all his pay goes to ComStar for transmissions to various military record depositories in search of answers.

Marcos appears middle-aged, with brown hair and eyes. Even with several scars on his face from his mysterious past, Marcos is said to look strikingly like Thomas Marik, and rumors persist that he is an illegitimate heir of the Free Worlds throne. However, this is pure speculation, mainly serving to add color to the legend of Snord's Irregulars.

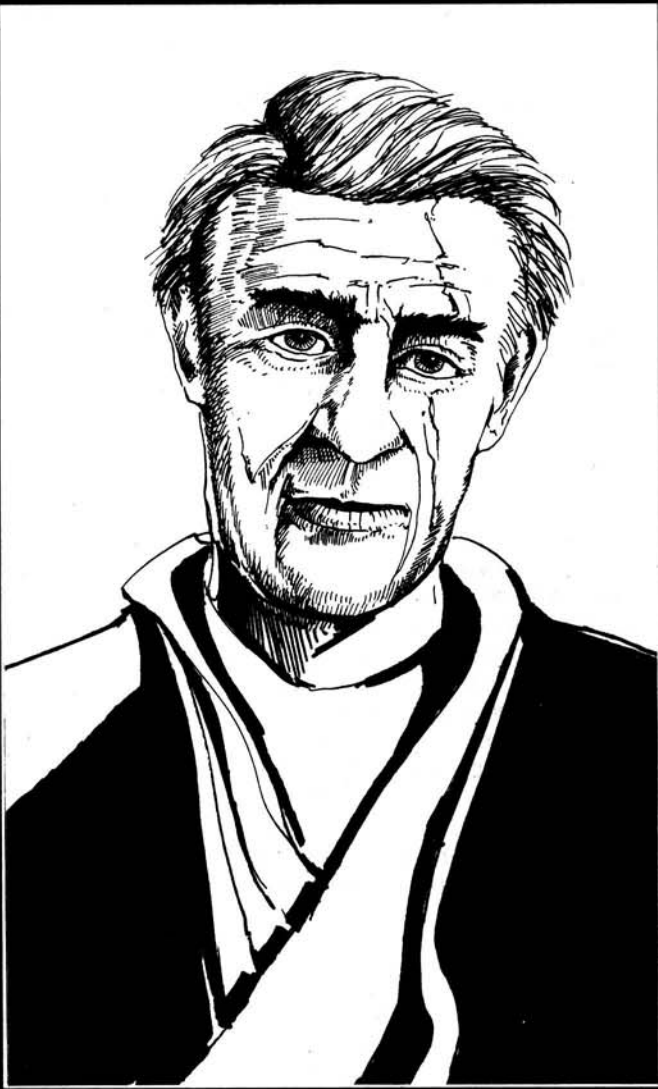

#### Warrior Data:

BOD - 9

DEX - 8

LRN - 11

CHA - 8

PIB - 5

HTK - 90

Total XP: 76,900

XP Available: 6,000

#### Equipment:

Vibro Blade (hidden in a sheath on right arm)

#### Notes:

Cannot remember his past.

#### Known Skills:

	Skill Level	Attribute Target	Modified Skill Roll Target
Gunnery/ Mech	7	8	1
Leadership	6	8	2
Piloting/ Mech	6	8	2
Pistol	5	8	3
Rifle	4	8	4
Technician	4	7	3
Tactics	2	7	5

**Age:** 42  
**Home Planet:** Clinton  
**Mech Type:** *Spartan*  
**Mech Status:** Excellent

Tempest is the feisty daughter of original Irregular Solomon Storm. Tempest was born on Clinton to Solomon's second wife Bonnie and was raised in the tradition of Snord's Irregulars. As her father did, Tempest loves old movies and laser-disk dramas. She joined the Irregulars in 3026, piloting one of the stripped-down BattleMechs that Cranston recovered from the cache on Phecda. The *Centurion* she piloted was in excellent condition and she served in several battles alongside her father during the Fourth Succession War.

In the 3039 attack on Vega, the Irregulars found themselves in several fierce pitched battles. During the worst of these, Solomon Storm was cut off from the rest of the Third Company. When he realized that he faced almost a full company of BattleMechs with little chance to flee, Solomon did the least expected thing, and charged into battle. The Kurita BattleMechs were initially driven back, stunned that a mercenary would charge rather than surrender. Once they rallied, however, their forces destroyed Solomon's *Sentinel*. By the time Tempest and the rest of her lance arrived, her father had fallen.

This incident hardened Tempest into a deadly warrior. Even Deb H'Chu is stunned by the level of violence of which Tempest is capable in combat, especially against the forces of the Draconis Combine. Rhonda has reprimanded her several times for excessive violence, but these warnings have not dulled her deadly edge.

While her bitterness for the loss of her father endures, she does maintain his traditions with the Irregulars, including his acquisition of old movies. Since 3039 she has contributed several collectibles to the Irregulars' museum.

When she is not on duty, she is often found with Third Company's Dalid "Darkside" Burns, the man who replaced her father in Snord's Irregulars. It is believed that the two are romantically involved, but none have been willing to ask the tempestuous Tempest.



**Warrior Data:**

BOD - 8  
 DEX - 11  
 LRN - 8  
 CHA - 7  
 PIB - 8  
 HTK - 80  
 Total XP: 57,000  
 XP Available: 5,800

**Equipment:**

Mauser and Gray Needler Pistol  
 Her father's bullwhip

**Notes:**

Collects old movies.

**Known Skills:**

	Skill Level	Attribute Target	Modified Skill Roll Target
Athletics	2		
Acrobatics	2	8	6
Climbing	2	8	6
Running	1	8	7
Swimming	1	8	7
Brawling	4	8	4
Gunnery/ Mech	5	7	2
Leadership	2	8	6
Piloting/ Mech	5	8	3
Pistol	3	7	4
Tactics	6	8	2
Technician	1	8	7

# CYNDOS THOMLINSON 27

**Age:** 44

**Home Planet:** Trent

**'Mech Type:** *Mercury*

**'Mech Status:** Excellent. There is a painting on the right side of the cockpit of a large Jack of Spades, the logo of the Blackjack School of Conflict.



Cyndos Thomlinson is the eldest of Bright Thomlinson's four children and the only one with a strong desire to follow in her father's footsteps as a MechWarrior. She graduated from the Blackjack School of Conflict near the top of her class. Unfortunately, she found that the LCAF was not compatible to her training at Blackjack. Instead, her combat skills earned her a position in the Recon Lance of Snord's Irregulars First Company in March 3026.

Cranston had reservations about Cyndos' lack of practical combat experience, but those fears were eased during scattered actions over the next couple of years, and eliminated in 3028, on Volders.

During the battle, a handful of MechWarriors found themselves engaged prematurely with Snord's Irregulars. In a skirting action, Cyndos' Recon Lance moved in to prevent the enemy CO from escaping the bulk of Snord's unit. During that fight, Cyndos, in only a light *Spider*, squared off against several medium and heavy BattleMechs. While her lance's stalling action worked, it cost the unit Cyndos' BattleMech for several months of repair.

Her skills have improved even more since that time, especially since receiving her new *Mercury*. Her actions in the fighting for Vega proved she is a skilled MechWarrior, but once again she lost her BattleMech. Rhonda rewarded her with a brand-new *Mercury*. In 3033, Cyndos was promoted to lieutenant and Recon Lance commander as a reward for her leadership skills.

## Warrior Data:

BOD - 10

DEX - 9

LRN - 9

CHA - 8

PIB - 6

HTK - 100

Total xp: 120,000

xp Available: 300

## Equipment:

Mauser 960 Assault System

## Notes:

Her best friend is Daniel Trump.

## Known Skills:

	Skill Level	Attribute Target	Modified Skill Roll Target
Brawling	4	7	3
Diplomacy	2	8	6
Gunnery/ Mech	5	8	3
Leadership	5	8	3
Piloting/ Mech	6	8	2
Rifle	3	7	4
Streetwise	3	8	5
Tactics	4	7	3



**Age:** 40

**Home Planet:** Skye

**'Mech Type:** *Spartan*

**'Mech Status:** Excellent. It has the name "Atomic Doll" painted in pink under the cockpit windshield.

Sharonus Wayne began her career with Snord's Irregulars in the usual way. A MechWarrior serving with the Nineteenth Lyran Guards, she deserted her post as sentry on Baxter and entered the town of Dington. Her commanding officer discovered her in a small curio shop attempting to purchase a rare Barbie Doll for her collection.

The CO of the Nineteenth Arcturan Guards, Marshall Tommy "Too Old" Gaherty, contacted Cranston Snord, who at the time was looking for a replacement for John Malvinson. While Marshall Gaherty saw that Sharonus had promise as a MechWarrior, he felt her outside interests might make her an ideal Irregular. The two commanding officers reached an agreement and in 3035, Sharonus transferred to Snord's Irregulars Command Company Command Lance.

Sharonus piloted a *Clint* during her first few years with the Irregulars. During the Star league upgrade in 3037, her *Clint* was replaced by a *Spartan*.

Sharonus' first heavy combat came in the War of 3039, when the Irregulars participated in the invasion of Vega. Over several engagements, she proved herself a worthy opponent for the skilled MechWarriors of the Combine.

On one occasion she overheard a Kurita warrior make a disparaging remark about her BattleMech (the Atomic Doll), and she immediately challenged him to a duel. In the tradition of the Star League gunslingers, Sharonus, in her *Spartan*, met the Kurita warrior in his *Awesome*. With the Irregulars and several Kurita BattleMechs observing, Sharonus mauled her opponent's 'Mech, forcing him to punch out. As the other Kurita BattleMechs were allowed to withdraw undisturbed, Sharonus marked her kill in a unique manner.

From that time forward, she has left the calling card of a headless doll in the cockpit of each BattleMech she has bested in combat.

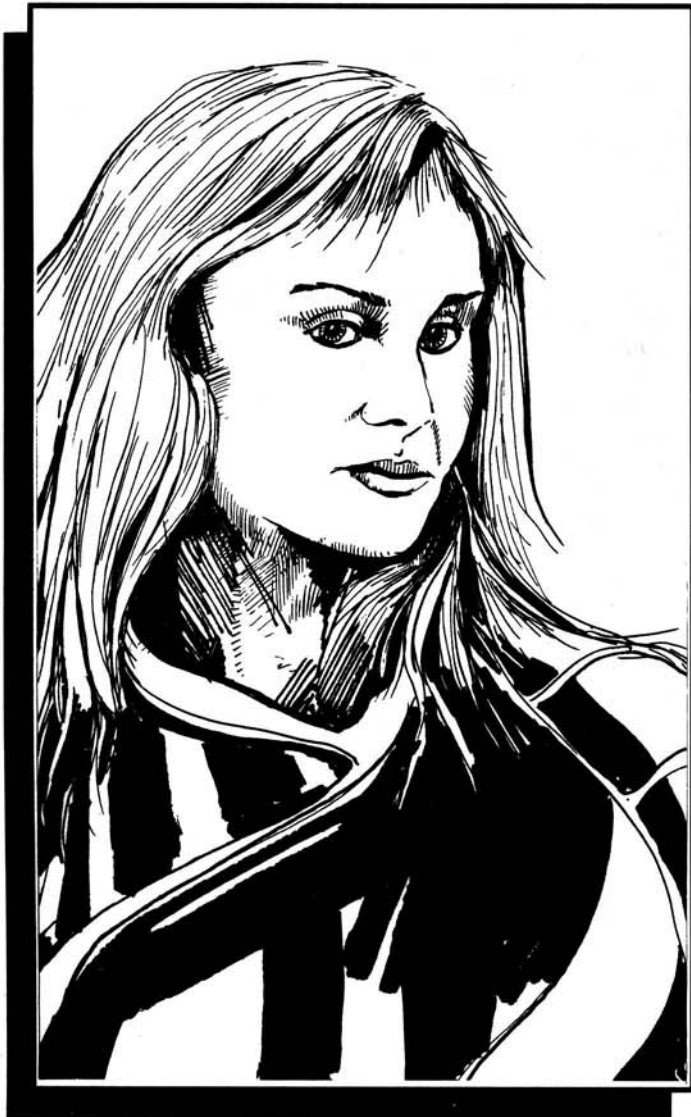

**Warrior Data:**

BOD - 9  
DEX - 8  
LRN - 6  
CHA - 9  
PIB - 1  
HTK - 90

Total XP: 87,900  
XP Available: 2,800

**Equipment:**

Mauser 960 Assault System  
(stored in cockpit)

**Notes:**

Collects rare dolls.

**Known Skills:**

	Skill Level	Attribute Target	Modified Skill Roll Target
Brawling	5	8	3
Gunnery/ Mech	5	8	2
Leadership	2	8	6
Piloting/ Mech	5	8	3
Rifle	6	8	2
Streetwise	2	8	6
Survival	2	8	6

# RECOVERED STAR LEAGUE EQUIPMENT

DATE: 25 March 3038

TO: Precentor Martial Anastasius Focht

FROM: Adept Brandon Lee

RE: Snord's Irregulars, BattleMech Types and Origins

For the past seven months we have conducted a full investigation into the origins of the BattleMechs in possession of the Federated Commonwealth mercenary unit known as Snord's Irregulars. This was per your order based on rumors that their 'Mechs were stolen or otherwise appropriated from ComStar. We do not yet know the origins of their new equipment, but we have been able to verify that it did not come from our own inventory.

I regret to inform you that our ROM operatives have not yet been able to infiltrate this tight-knit organization. The founder of the unit, Cranston Snord, allegedly has ties to Jaime Wolf of Wolf's Dragoons. A joint investigation has uncovered financial transactions between the two units early in the Third Succession War, but thus far cannot conclusively establish a permanent link between the two units.

Given the background and nature of this unit and their fondness for collecting artifacts and items of the Star League, we draw the conclusion that at some point the Irregulars uncovered a large cache of BattleMechs and other Star League equipment. Our operatives have filmed these 'Mechs training, and they appear to have mint-condition technology thought exclusively maintained by ComStar for three centuries.

Some of the BattleMechs and other vehicles in their use are older models, with limited numbers in service. Most puzzling are photos and reports from ROM agents claiming the 'Mechs the Irregulars possess were stolen from Com Guard troops. Having conducted a full (and costly) inventory of all posts and stations, we have accounted for only a handful of equipment, and none are the *Spartan* and *Excalibur* BattleMechs that Snord's Irregulars currently own. Most of these aforementioned discrepancies are clerical mistakes. A full accounting will be available within the next month for your approval.

My research into Cranston and Rhonda Snord and other Irregulars is inconclusive at best. We know that much of their background documentation is forged, yet we do not know how, given the present state of technology. Their association with Wolf's Dragoons is tangible, but links in recent years are difficult to verify.

I have enclosed information on the two rather unique BattleMech classes in use by Snord's Irregulars, along with data on one heavy artillery tank. While we have a few of each, their statistics are not common knowledge, even within ComStar. Those in the hands of the Irregulars represent the first time in centuries that anyone other than ComStar has fielded these classes of equipment.

Copies of this report are being included in all command personnel monthly intelligence reports, per your orders.

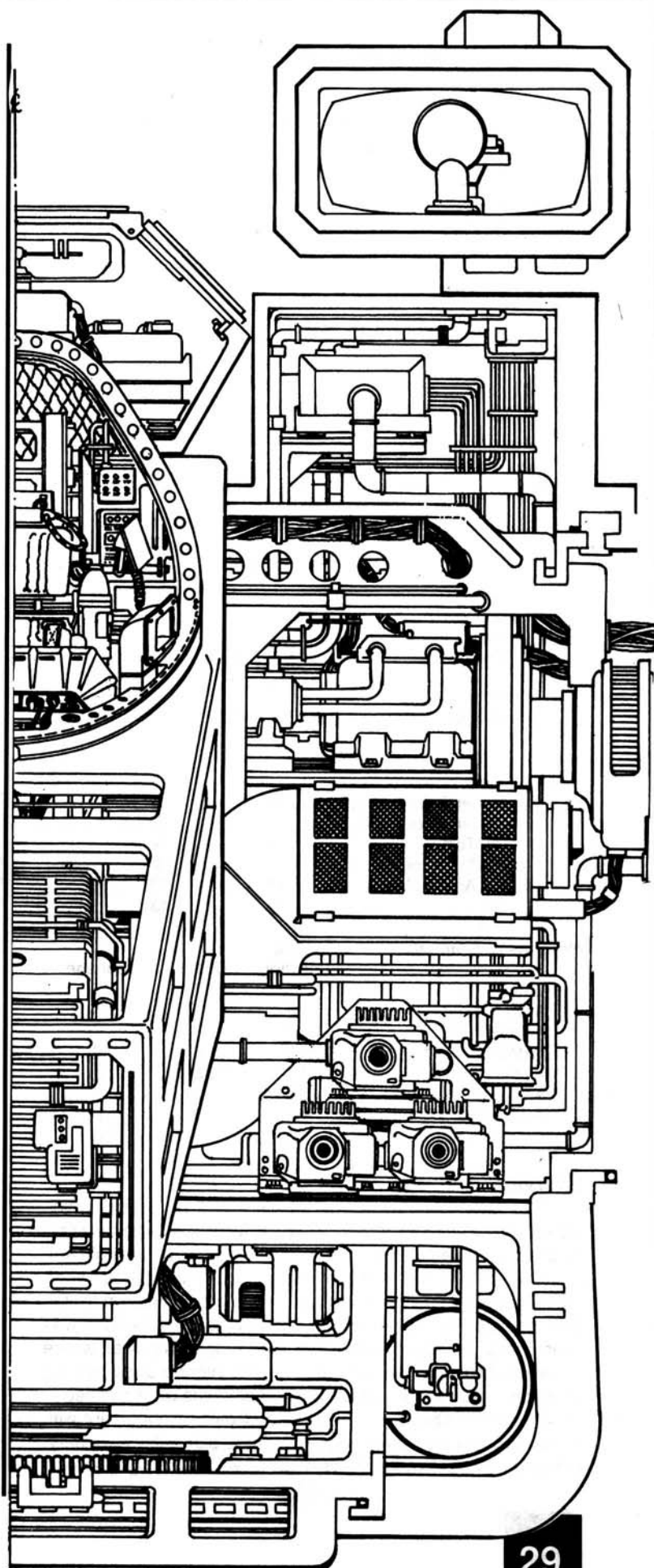

## TYPE: EXC-B1 EXCALIBUR

**Mass:** 70 tons

**Chassis:** Corbin 1

**Power Plant:** Ford 350 XL

**Cruising Speed:** 54 kph

**Maximum Speed:** 86 kph

**Jump Jets:** None

**Jump Capacity:** None

**Armor:** Pribak 9000

### Armament:

1 Grizzard Model 200 Gauss Rifle

1 Artemis IV FCS

1 Ingrid Systems LRM 20 Missile System

1 Strafe 44 Small Pulse Laser

1 McArthur Anti-Missile System

**Manufacturer:** Yankee Weapons Systems

**Communications System:** Faulk 203 Comset

**Targeting and Tracking System:** KBC Starsight Model

### Equipment

		Mass
Internal Structure:		7
Engine:	350 XL	14.75
Walking MP:	5	
Running MP:	8	
Jumping MP:	0	
Heat Sinks:	12	2
Gyro:		4
Cockpit:		3
Armor Factor:	120	7.5

	Internal Structure	Armor Value
Head	3	9
Center Torso	22	16
Center Torso (rear)		5
R/L Torso	15	14
R/L Torso (rear)		5
R/L Arm	11	13
R/L Leg	15	13

### Weapons and Ammo

	Location	Critical	Tonnage
Gauss Rifle	RA	7	15
Ammo Gauss Rifle (16)	RT	2	2
Artemis IV FCS	LT	1	1
LRM 20	LT	5	10
Ammo LRM (12)	LT	2	2
Anti-Missile System	LT	1	.5
Ammo Anti-Missile (12)	CT	1	1
Small Pulse Laser	LA	1	1

### Overview:

The *Excalibur* was named for its fearsome shape, which resembles a medieval knight. This BattleMech's large Grizzard Gauss rifle was extended through a dummy hand on the right arm of the 'Mech and its barrel fashioned to look like a broadsword. The *Excalibur* was introduced in a limited production run for the Star League Defense Force in 2520. When produced it was considered perfect for delivering long-range firepower where there was little chance of the 'Mech encountering close-combat situations. Archival records indicate that it was distinguished in service during Operation Smother and gained popularity with those divisions assigned to garrison duty along the Periphery. However, many *Excaliburs* were destroyed in the tight fighting

conditions that often prevailed in Civil War battles. The end of the Civil War left only a handful of *Excaliburs* operational, mostly in the hands of the 328th Royal BattleMech Division. While some remained in the Inner Sphere, most were taken by the Exodus fleet. Our own forces field less than a dozen *Excaliburs* in active service. These are the only known operating 'Mechs of this class other than those Snord and his Irregulars possess.

### Capabilities:

*Excaliburs* are designed for short, violent, long-range fights. They carry too little ammunition for a prolonged battle. The core of this 'Mech's offensive capability is its Gauss rifle, coupled with the long-range missile system.

The *Excalibur's* Gauss rifle is the Grizzard Model 200, a system known for accuracy and endurance. Legends from the Civil War tell of MechWarriors using the massive barrel like a broadsword in combat, though such use will more than likely ruin the weapon. The Ingrid Systems LRM is slightly less reliable than the well-known Holly Missile Rack, but it is guided by an Artemis IV fire control system. This combination makes the *Excalibur* a deadly opponent at long ranges. The primary weakness of this BattleMech is its lack of armor. Though it has adequate speed and mobility, the *Excalibur* is only lightly armored. Most MechWarriors piloting this class of 'Mech favor hit-and-run tactics, making use of extensive cover and firing only when they are at minimum risk of being a target. During the Civil War, *Excalibur* pilots were often known as "Streakers" (slang for Yellow Streak), an insult referring to their refusal to stand and fight.

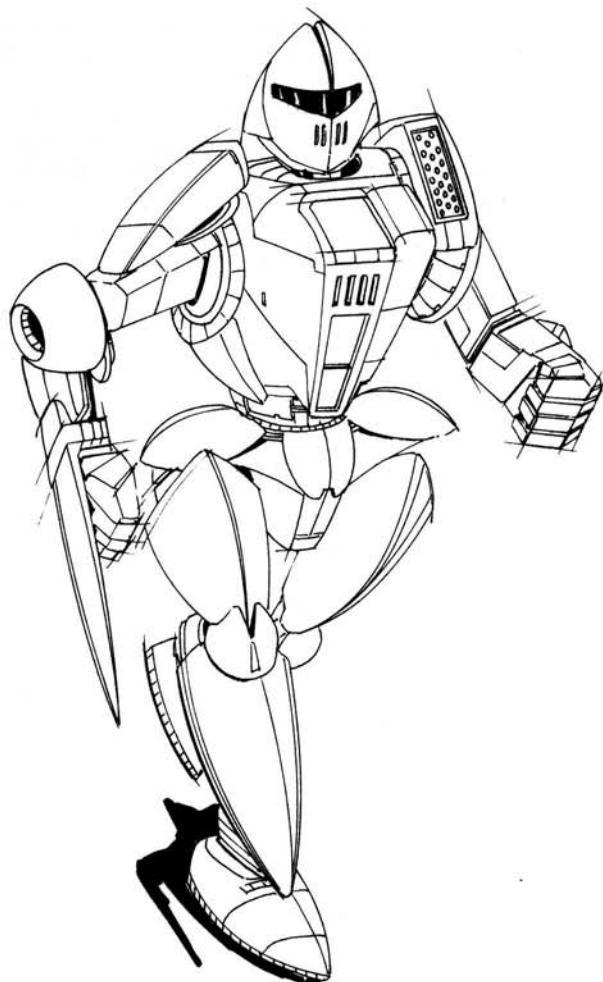



## TYPE: SPT-N1 SPARTAN

**Mass:** 80 tons

**Chassis:** Geometric 500 Hard Core

**Power Plant:** Dantrus 400 XL

**Cruising Speed:** 54 kph

**Maximum Speed:** 86 kph

**Jump Jets:** None

**Jump Capacity:** None

**Armor:** Strausburg Armaments 206 Diamond Weave

**Armament:**

1 Kinslaughter H Class ER PPC

3 Blankenburg Medium Pulse Lasers

2 Holly SRM Streak Missile Racks

1 McArthur Anti-Missile System

**Manufacturer:** Martinson Armaments

**Communications System:** Blow 300 SNA Net

**Targeting and Tracking System:** Scope 40 RNDST

Equipment		Mass
Internal Structure:		8
Engine:	400 XL	26.25
Walking MP:	5	
Running MP:	8	
Jumping MP:	0	
Heat Sinks:	13	3
Gyro:		4
Cockpit:		3
Armor Factor:	224	14
	<i>Internal Structure</i>	<i>Armor Value</i>
Head	3	9
Center Torso	25	31
Center Torso (rear)		12
R/L Torso	17	26
R/L Torso (rear)		9
R/L Arm	13	26
R/L Leg	17	25

### Weapons and Ammo

	Location	Critical	Tonnage
ER PPC	LT	3	7
Medium Pulse Laser	RA	1	2
Medium Pulse Laser	RA	1	2
Medium Pulse Laser	RA	1	2
Streak SRM-2	CT	1	1.5
Streak SRM-2	CT	1	1.5
Ammo SRM Streak (100)	RT	2	2
Anti-Missile System	RT	1	.5
Ammo Anti-Missile (24)	RT	2	2
TAG (For Arrow IV)	LT	1	1

### Overview:

Just before the Civil War, the Star League began full production of the *Spartan* Class BattleMech at Terra's Martinson Armaments facility. With just more than 600 of these 'Mechs in service, Stefan Aramis' coup resulted in the destruction of the manufacturing facility, forever ending the production of this BattleMech. The *Spartan* was originally conceived as a general-service BattleMech, capable of deadly firepower at long, medium, and short ranges. It had greater mobility than other BattleMechs of the same size, such as the *Crockett* and the *Thug*, yet managed to maintain large destructive potential. At the fall of the Star League, most *Spartans* were dispersed throughout the Inner

Sphere, with only a handful remaining operational. Including the heavy losses of the First and Second Succession War, only 19 are known to be in service within our own Com Guards. At least two others are in use in mercenary units working for the Taurian Concordat and the Marian Hegemony. Those in use by Snord's Irregulars are priceless, both for their current condition and their future usefulness for spare parts.

### Capabilities:

The core of the *Spartan's* long-range firepower is its Kinslaughter extended-range particle projection cannon. With special insulating cones, this weapon fires cooler than many other models and is easier to maintain.

For medium-range combat, the *Spartan* carries three medium pulse lasers manufactured by Blankenburg Technologies. These weapons have a slightly shorter range than their continuous-firing counterparts, but inflict more damage upon impact. All three are mounted in tandem on the right forearm of the *Spartan*. In close-range combat, the *Spartan* makes use of two Streak short-range missile packs, both fitted in the upper center torso of the BattleMech, just below the cockpit. These systems make good engagement weapons in close quarters. An auxiliary escape hatch provides an emergency exit from the cockpit to the missile exit ports when the ejection system is damaged.

Speed is what separates the *Spartan* from other BattleMechs of the same era and weight. While many 'Mechs of the same weight max out at around 65 kph, the *Spartan* is able to run faster than 86 kph, easily outdistancing most 'Mechs of the same weight or greater. This allows *Spartan* pilots to control their engagement ranges and make use of their superior speed defensively.

The McArthur anti-missile system on the *Spartan* is mounted at the waist of the BattleMech. It has jamming difficulties, particularly in models used by the Com Guards for the past two and a half centuries, but simple field modifications can repair the problem when it occurs, only after combat.

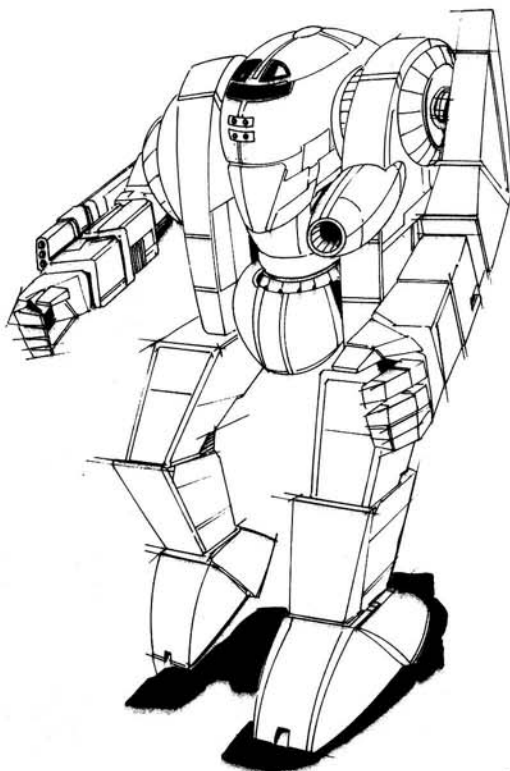

## TYPE: PDL-A5 PADILLA HEAVY ARTILLERY TANK

**Mass:** 75 tons

**Chassis:** Cath-Star 11

**Power Plant:** Ragusson 370 XL

**Cruising Speed:** 54 kph

**Flank Speed:** 86 kph

**Armor:** 1/Star Slab

**Armament:**

1 Katyusha Arrow IV Missile Launcher

2 Medium Martell Pulse Lasers

1 Burow Anti-Missile System

**Manufacturer:** Leopard Armor of Terra

**Communications System:** Teldon 19

**Targeting and Tracking System:** Scope 30 RDNST

**Equipment**

		Mass
Internal Structure:		7.5
Engine (fusion):	375 XL	19.25
Fusion Shielding:		9.75
Cruising MP:	5	
Flank MP:	8	
Heat Sinks:	10	
Control Equipment:		4
Armor Factor:	96	6
	<i>Armor Value</i>	
Front	29	
Left Side	27	
Right Side	27	
Rear	13	
Turret	0	

**Weapons and Ammo**

	Location	
Arrow IV Missile System	Front	15
Arrow Ammo (30)	Body	6
Medium Pulse Laser	Front	2
Medium Pulse Laser	Front	2
Anti-Missile System	Body	.5
Anti-Missile Ammo (24)	Body	2
TAG (For Arrow IV)	Front	1

**Overview:**

The Padilla Heavy Artillery Tank was named in honor of Colonel Alfred Padilla of the SLDF, killed during Operation Smother. Leopard Armor of Terra designed the Padilla as a long-range missile launcher with the Arrow IV missile system in the sleek turret as its primary weapon. The Padilla is a rear-area vehicle with a high degree of mobility. This allows it to cover a wide area and to change its targeting profile quickly, making it both difficult to hit and useful in a mobile-defense situation.

The Padilla is designed to work in conjunction with BattleMechs acting as spotters. During the era of the SLDF, Padillas were paired with light, fast BattleMechs equipped with Target Acquisition Gear (TAG), which would skirt the enemy defenses, calling for missile shots from the Padilla. Almost all existing Padillas were destroyed during Operation Liberation; only 15 were in the hands of House Liao at the outbreak of the First Succession War. Most had the Arrow Systems removed when supplies of Arrow missiles dwindled. Our own Com Guards have 15 of these systems still operational and in their original weaponry configuration. These are presently stationed primarily within the Lyrn Commonwealth.

**Capabilities:**

The core of the Padilla's offensive capabilities is the Katyusha Arrow IV missile launcher. This system, with its extensive range and damage capability, makes it invaluable in combat. A number of Spartans in Snord's Irregulars are equipped with TAG for this system, and it provides excellent long-range cover for the unit's operations. Lightly armored, the Padilla relies primarily on speed as its strongest defense. With a flank speed of 54 kph, only fast reconnaissance BattleMechs can close on one of these vehicles.

For close-combat situations, the Padilla carries two medium pulse lasers, prototypes from the now-obsolete Martell Weapons works on Terra. For close-quarters defense, the tank also supports an often less-than-reliable Burow anti-missile system. This system was replaced just before the Civil War with the McArthur system, but the Padillas were never called in for refit.

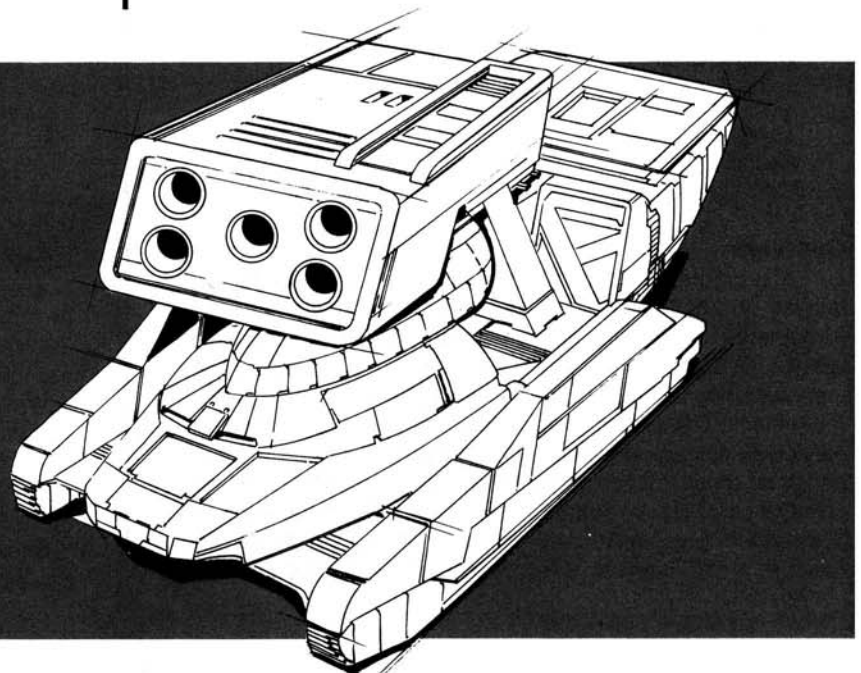

# SCENARIOS





# TANKS A LOT

## AN AGE-OLD QUESTION

Rhonda adjusted the volume on her auxiliary headset, turning down the chords of "Heartbreak Hotel."

Since the Irregulars had landed on Volders, there had been little open fighting. Narhal's Raiders had enjoyed most of the action, while she and the rest of the her company attempted to locate a hidden deposit of computer manifests, lost during the fall of the Star League.

An hour ago Lieutenant-General Gerould had asked her to take two lances and head off along the far flank of Hopkins, hoping to cut off any reinforcements from the local garrison. The general was taking the Raiders into the heart of the enemy's stronghold, located in bunkers built in and around the ruins of the dead city. Thus far Rhonda had found no action, just plenty of boredom.

Suddenly her long-range sensors flashed to life. She signaled a silent code to the rest of the company for scans, and fed their information into her own screen.

It was ground armor. According to the sensors, there were ten tanks moving along the flank of the Irregulars. They had probably not detected the Irregulars yet, but she knew it was only a matter of time.

"All right, Irregulars, prep for action." she signaled her BattleMechs, "This is the show we've been waiting for. Ten ground-pounders against eight 'Mechs. Some are heavies and pack enough firepower to flatten us. I want a wide V formation, Fire Lance on the left flank."

"Well, Rhonda, looks like we get to answer that age-old question," signaled Bright Thomlinson.

"What's that, Bright?"

"Which *really* is better, tanks or 'Mechs."

"No question in my mind. In all of my years of fighting, I've never witnessed a tank jumping up and down on a BattleMech until it was a greasy spot in the middle of the road, but I'm willing to put it to the test."

Rhonda fired her jump jets and cleared the ridge line, her autocannon spraying the distant dust clouds at extreme range.

## GAME SET-UP

Lay out the **BattleTech** maps as shown.

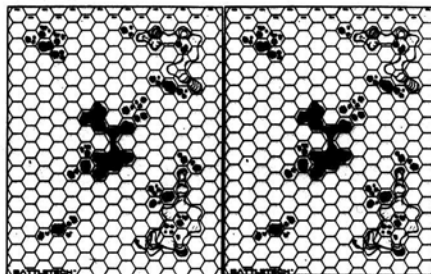

### DEFENDER

Defender is the Kurita Third Volders Armored Assault Company, a garrison raised and supported on Volders. All their tanks and other vehicles are in good condition.

#### Command Lance

*Tai-i Sen-Chu Lingh (Piloting 1, Gunnery 2), Von Luckner Heavy Tank*  
*Chu-i Vell Torris (Piloting 3, Gunnery 4), Manticore Heavy Tank*  
*Travis Chin (Piloting 4, Gunnery 1), Hunter Light Support Tank*

#### Strike Lance

*Chu-i Bentley Markisson (Piloting 2, Gunnery 4), Demolisher Heavy Tank*  
*Banglor Follis (Piloting 1, Gunnery 1), Hetzer Wheeled Assault Gun*  
*Teresa Lorrison (Piloting 4, Gunnery 5), Striker Light Tank*  
*Marcus Serret (Piloting 5, Gunnery 4), Galleon Light Tank*

#### Mobile Lance

*Chu-i Dakkari Bureau (Piloting 3, Gunnery 3), Packrat LRP Vehicle*  
*Terrence Kivis (Piloting 1, Gunnery 1), Galleon Light Tank*  
*Vistoli Uriksson (Piloting 2, Gunnery 4), Striker Light Tank*  
*Gabbon Lawrence (Piloting 1, Gunnery 2), Galleon Light Tank*

### Deployment

The Third Volders Armored Assault Company enters on the east edge of the east map on Turn 1. The Defender automatically loses all Initiative rolls in Turn 1 and must move his vehicles onto the map before Snord's Irregulars move.

### ATTACKER

The Attacker consists of Snord's Irregulars Third Company (Rhonda Snord's Irregulars) Command and Fire Lances. All BattleMechs are in good condition.

#### Command Lance

*Captain Rhonda Snord (Piloting 2, Gunnery 2), Shadow Hawk*  
*Lieutenant Terry Malvinson (Piloting 3, Gunnery 3), Phoenix Hawk*  
*Shalimar Windall (Piloting 2, Gunnery 2), Crusader*  
*Walker Roche (Piloting 4, Gunnery 6), Griffin*

#### Fire Lance

*Lieutenant Bright Thomlinson (Piloting 2, Gunnery 1), Rifleman*  
*Solomon Storm (Piloting 2, Gunnery 3), Wolverine*  
*Linda Thomlinson (Piloting 6, Gunnery 3), Scorpion*  
*Blade Windall (Piloting 4, Gunnery 4), Warhammer*

### Deployment

Snord's Irregulars enter on the west edge of the west map on Turn 1.

### VICTORY CONDITIONS

The two sides are equally matched in tonnage. Both sides must keep track of the tons of enemy units destroyed.

The scenario lasts 12 turns. The side which has destroyed the most enemy tonnage at that time wins. The margin of victory is the difference in destroyed tonnage.

### VICTORY TABLE

Winner's Margin	Result
40 tons or less	Marginal Victory
41-55 tons	Regular Victory
56 or more tons	Decisive Victory

### SPECIAL RULES

Treat all woods as Heavy Woods.

The Fourth Succession War altered the face of the Inner Sphere, and in the process produced several classic combat situations. The fight between Snord's Irregulars Third Company and the Third Volders Armored Assault Company is one example.

Ton for ton, the two sides in this battle were evenly matched. The Kurita defenders had ten ground-based tanks, ranging from a Demolisher and a Von Luckner to Galleons and a Packrat. Facing them were two 'Mech lances of Rhonda Snord's Irregulars. For many historians and arm-chair tacticians, this was a classic showdown on the advantages and disadvantages of BattleMechs versus conventional armor.

At first the match was even, with heavy hits and damage on both sides. However, the Irregulars brought their BattleMechs up to point-blank range, using kicks and jumps to maul their turtle-like opponents. At close range the defensive capabilities of the tanks seemed to disintegrate, and the Third Volders broke and fled as best they could.

The battle outside the ruins of Hopkins is now studied at most Federated Commonwealth military academies as the standard approach for BattleMechs against ground vehicles.

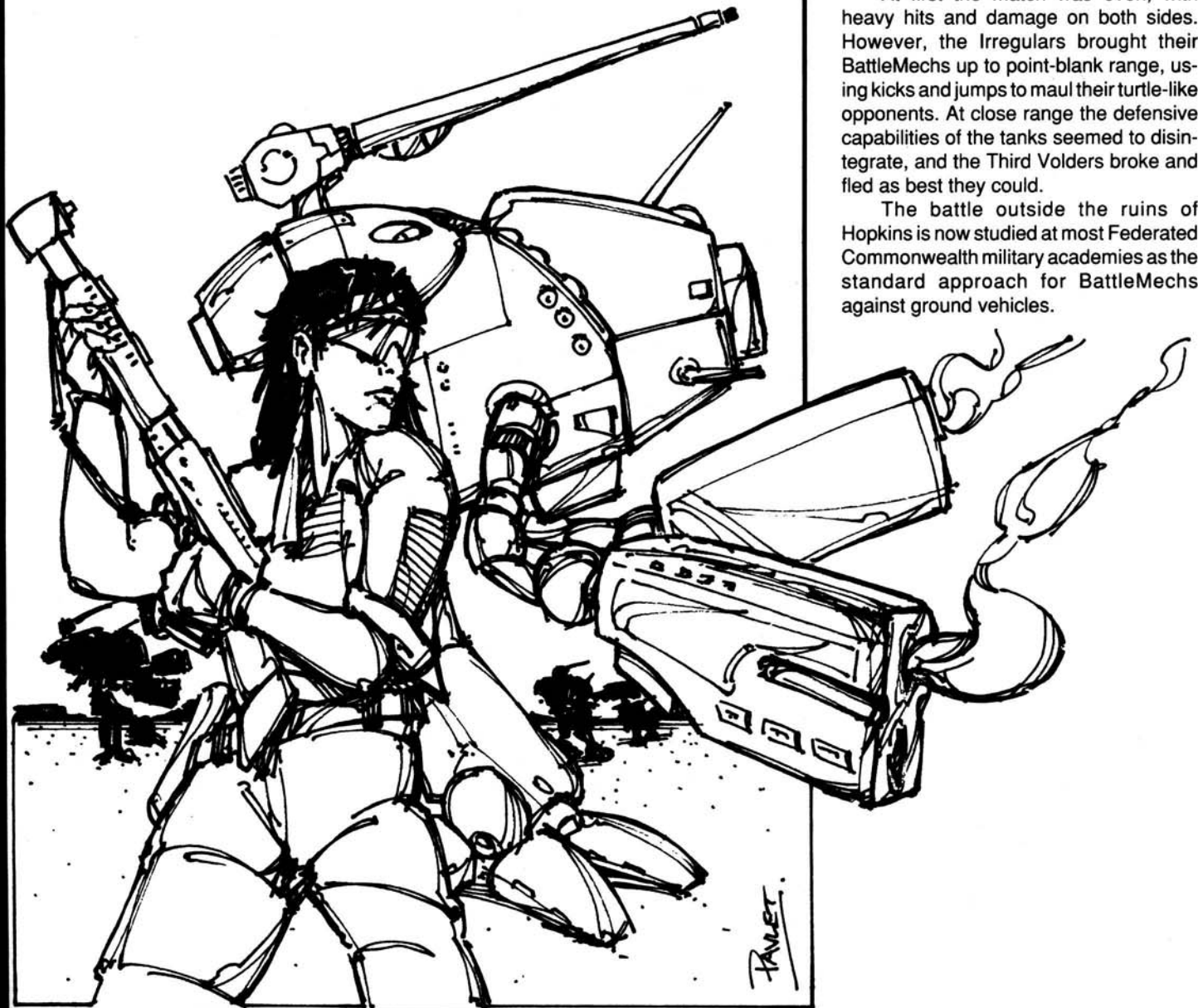

# SNAKES IN THE GRASS

## JACK IN THE BOX

Shorty Sneede pulled his *Rifleman* into a trot, heading toward the *Vulcan* BattleMech. The Kurita 'Mech responded to the charge with a barrage. Explosions from impacting shells traced along the *Rifleman*'s left and center torso, but the laser shot went wide.

Shorty stopped and leveled his auto-cannons and lasers. This was almost too easy. In a precise shot he tore off the *Vulcan*'s right arm and left gaping holes in what had been a clean, well-armored right torso. Despite rising heat in the cockpit, Shorty took aim for what he thought would be a final volley against his crippled foe.

Without warning he felt the impact of cannon fire in his back. He pivoted his torso and saw a Kurita *Trebuchet* standing only 30 meters away. "Where did that come from?" he spat into his commlink, turning to target his new foe.

"Shorty, this place is booby-trapped!" Rhonda yelled. Shorty saw missile warning lights as he fired a shot that missed the *Trebuchet*, now running past him.

"We've got a full company of 'Mechs popping up out of holes all over the place. The readings say these burrows look like some sort of old Star League bunker."

Just great, Shorty thought. *I thought this kind of stuff only happened to the Gray Death Legion—finding an SLDF base in the middle of a battle.* Shorty turned back to where the *Vulcan* had been but saw instead a *Warhammer*, blazoned with the Draconis Combine dragon. *This day gets better and better.* Shorty broke into a full run, trying to escape the ambush. One of the PPC's shots narrowly missed the back of his cockpit, causing the internal lights to fade and flicker back on again. *Close, too blasted close.*

The Kurita regiment's mobile HQ suddenly surfaced out of a concealed tunnel, making a wide run for the open plains. Terry Malvinson passed Shorty to take on the *Warhammer*, and the static discharge of PPC fire broke out as the two began a deadly dance. Shorty carefully leveled his *Rifleman*'s massive artillery arms into place and locked on the mobile HQ.

"Ambush the Irregulars, eh?" he muttered. "We work best under pressure."

He thumbed the firing stud and in a brief flash tore off the back of the mobile HQ, spinning it to a halt. One for the road...

## GAME SET-UP

Lay out the BattleTech maps as shown.

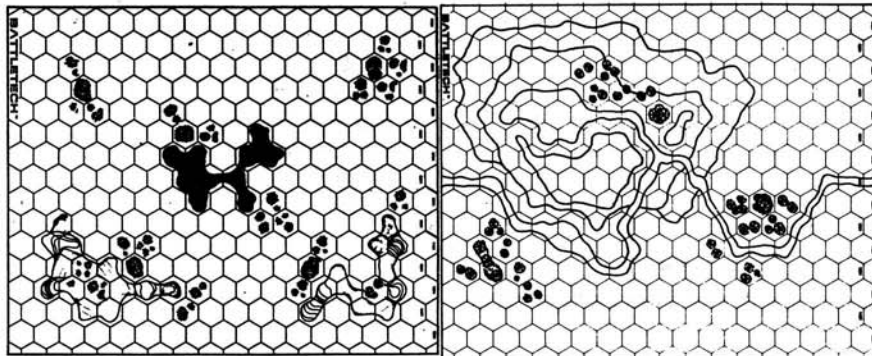

## DEFENDER

The Defender is the First Volders Regimental Command Company. All of their 'Mechs are in good condition.

### Command Lance

*Tai-sa Veng Lo Ho* (Piloting 2, Gunnery 3), *Grasshopper*  
*Tai-i Kraven Losti* (Piloting 1, Gunnery 3), *Dragon*  
*Chu-i Darleen Dorviski* (Piloting 3, Gunnery 1), *Panther*  
*Benniko Yareng* (Piloting 2, Gunnery 2), *Warhammer*

### Mobile Fire Lance

*Chu-i Kappara Shing* (Piloting 1, Gunnery 3), *Trebuchet*  
*Linda Velesko* (Piloting 4, Gunnery 4), *Crusader*  
*Veerman Hoost* (Piloting 3, Gunnery 2), *Panther*  
*Trey "Tapper" Kress* (Piloting 4, Gunnery 4), *Vulcan*

### Support Lance

*Chu-i Fay Vin* (Piloting 3, Gunnery 2), *Wasp*  
*Kay Vassar* (Piloting 2, Gunnery 2), *Spider*  
*Sev Torrman* (Piloting 4, Gunnery 5), *Jenner*  
*Leo Gray* (Piloting 3, Gunnery 3), *Locust*

### Headquarters

*Sho-sa Kravin* (Piloting 2, Gunnery 1), *Mobile Headquarters*

### Deployment

At the start of play, the Mobile Fire Lance units may each set up on any hex on the east map, at least four hexes from any edge.

The remaining forces may enter via the hidden entry points (see **Special Rules**). These forces must be on the board by turn 4 or they are considered destroyed.



## ATTACKER

The Attacker consists of combined elements of the Second and Third Companies of Snord's Irregulars. Some of the BattleMechs are damaged as indicated. All other equipment is in good condition.

### Second Company

#### Command Lance

Captain Samuel "Shorty" Sneede (*Piloting 1, Gunnery 1*), *Rifleman*  
 Lieutenant Jake Walmar (*Piloting 2, Gunnery 2*), *Warhammer*  
 Marleen Danules (*Piloting 5, Gunnery 5*), *Clint*  
 Carter Malvinson (*Piloting 6, Gunnery 5*), *Phoenix Hawk*

### Third Company

#### Command Lance

Captain Rhonda Snord (*Piloting 2, Gunnery 2*), *Shadow Hawk* (15 points of damage, in location(s) assigned by player. Also, it has lost one heat sink.)  
 Lieutenant Terry Malvinson (*Piloting 3, Gunnery 3*), *Phoenix Hawk*  
 Shalimar Windall (*Piloting 2, Gunnery 2*), *Crusader* (Has lost both machine guns and has only 20 points of armor on the right torso.)  
 Walker Roche (*Piloting 4, Gunnery 6*), *Griffin*

#### Support Platoon

Lieutenant Fasha Nagaraj, *Veteran*  
 Sergeant Baca Tsaprazis, *Veteran, Jump Infantry (Laser)*  
 Sergeant Nanette Warkentin, *Green, Motorized Infantry (SRM)*  
 Sergeant Roger H'Chu, *Regular, Jump Infantry (SRM)*  
 Corporal Darwin (Breaker) Morgan, *Regular, Motorized Infantry (Laser)*

#### Deployment

The Second Company Command Lance is placed anywhere on the west map at the start of play. On Turn 1 the remaining Irregulars must enter the north edge of either map.

## VICTORY CONDITIONS

Each side receives 2 points for each destroyed BattleMech. The Defender receives 1 point for each infantry unit destroyed. The Attacker receives 5 points for destroying the Defender's Mobile Headquarters.

The side with the most points at the end of 15 turns is the winner.

## SPECIAL RULES

Use the optional **Anti-BattleMech Infantry** rules in the **BattleTech Compendium** (pp. 47-8) for the Irregulars' infantry, who are extensively trained in anti-BattleMech combat.

### Hidden Deployment

Before play begins, the Defender must select any five hexes on the east map as hidden entry points, and note down their hex numbers. These represent the concealed SLDF tunnel locations where the Kurita forces are hiding. Up to two units may be hidden in each of these hexes.

Each unit will remain hidden until it attacks, moves, or has an enemy unit move into its hex or end its movement adjacent to it.

The Irregulars' major responsibility to Wolf's Dragoons and the Clans was to locate and control hidden Star League Defense Force bases still within the Inner Sphere. During operations on Volders, the Irregulars accidentally discovered one of these bases while searching the countryside for a stash of computer manifest chips.

The First Volders Regiment, a veteran unit of the Draconis Combine, had dug in and fought well against the invading LCAF forces. Narhal's Raiders had been tied down for three weeks attempting to destroy the regiment, but with little success.

Rhonda Snord requested permission to make a long-range probe, in the hopes of finding and capturing the regimental supply bunker. Four days after their engagement with the Third Volders, the Irregulars encountered a seemingly isolated lance of light BattleMechs. In reality, these 'Mechs were stationed on top of a hidden bunker complex the Kurita troops had only partially excavated.

More than a company of BattleMechs were hidden in its tunnels, covered with camouflage tarps and trap doors. The First Volders Regiment was using the location as their command center, and the Irregulars had stumbled across it.

As the Irregulars closed in on the four light BattleMechs, the remaining garrison defenders suddenly began to swarm from their hidden locations. Kurita 'Mechs appeared at point-blank range from all directions. While most commanders would have tried to pull back and regroup, Shorty Sneede and Rhonda Snord pressed their forces into the fray.

The Irregulars moved fast and were able to take out almost all of the defending 'Mechs. As the fight turned against his forces, *Tai-sho* Becker attempted to flee in his mobile headquarters, only to be captured by Rhonda.

The remaining defenders on Volders crumbled without their command and communications structure. Meanwhile, Snord's Irregulars began a careful evaluation and excavation of the SLDF bunker and discovered a vast storehouse of Star League BattleMechs, vehicles, and repair parts. The battle and subsequent discovery shaped Snord's Irregulars for years to come.

# BATTLE FOR THE THRONE

## RAID ON BORDON

—From transcript of an interview with Captain Jonathan Taylor, Thirteenth Marik Militia, Second Battalion, First Company.

Tape Number 120-44J, ComStar ROM Operative Tango Bravo—Brandon Lee, Sanctum Level Security Access.

Investigation: Activities of Cranston Snord's Irregulars

The first time I fought Snord was in 3012 when I was a sergeant in the Thirteenth Marik Militia on Castor. I got attacked by the Kell Hounds and Cranston Snord's Irregulars at the same time. It took about a year to get my 'Mech fixed.

When the Fourth War broke out, they sent my company to garrison Bordon's capital city, Frankenmuth. I didn't think much of the duty; the town was a little tourist trap, no strategic value there.

It didn't seem to matter, but there was a little museum in the town, with a lot of antiques taken from Terra just after the Liberation.

My company got word of a battalion of 'Mechs dropping only ten clicks from Frankenmuth. I was outnumbered, but I was hoping to catch these raiders off guard.

Sure enough, I ran smack-dab into a company of Snord's Irregulars at the edge of Lake Fairfield. Like a fool, I ordered my men to attack. Fog blocked out most of what we could see, but I thought this time things might go differently.

At first we seemed to do pretty good, but those Steiners made good use of the lake to keep cool. Over the long haul it was too much for me and my men. But I knew that Snord never just raided a planet. I figured he had some interest in Frankenmuth, so I detailed some 'Mechs to try and block him from getting through.

His *Archer* tore through most of my *Centurion's* chest armor like toilet paper. I tried to close with him, but the old man was too smart for that. He toyed with me, keeping his distance and pulverizing me with his missiles. By the time I realized he was jerking me around, it was too late. His Scout Lance had made a break for it and was on its way to town.

And for what? He acquired a rotting chair or something, and I never knew why. Me, I lost my left arm to one of his missiles.

You'd think I'd be smart enough not to mess with Snord twice, wouldn't ya?

## GAME SET-UP

Lay out the **BattleTech** maps as shown.

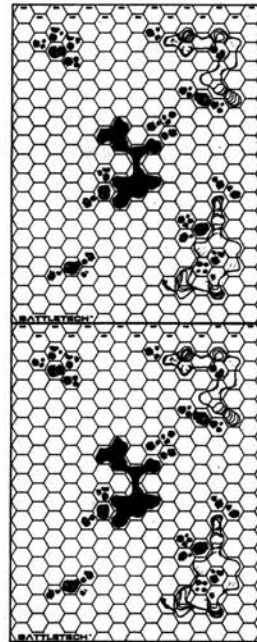

### DEFENDER

The Defender is the thirteenth Marik Militia, Second Battalion, First Company (Taylor's Terrors). All their BattleMechs are in good condition.

#### First Company (Taylor's Terrors)

##### Command Lance

Captain Jonathan Taylor (*Piloting 2, Gunnery 1*), *Centurion*  
Lieutenant Allen Forbes (*Piloting 1, Gunnery 2*), *Catapult*  
Sergeant Dana Hollis (*Piloting 2, Gunnery 4*), *Hermes II*  
Frank "Fireman" Sivitiz (*Piloting 1, Gunnery 4*), *Stinger*

##### Attack Lance

Lieutenant Stanley Pudlo (*Piloting 3, Gunnery 2*), *JagerMech*  
Elizabeth "Baby" Carrington (*Piloting 3, Gunnery 4*), *Awesome*  
Baxter Howell (*Piloting 5, Gunnery 4*), *Banshee*  
Darrian Rowels (*Piloting 4, Gunnery 2*), *Enforcer*

##### Scout Lance

Lieutenant Chris "Lawman" Rojem (*Piloting 2, Gunnery 2*), *Assassin*  
Felix "Fleet-Foot" Ferrington (*Piloting 4, Gunnery 2*), *Cicada*  
Samantha Tabbs (*Piloting 3, Gunnery 3*), *Javelin*  
Kinkelli Kavut (*Piloting 4, Gunnery 4*), *Jenner*

### Deployment

The Defender enters along the south edge of the south map on Turn 1. All of this unit's BattleMechs must be on the map by Turn 3, but may enter in any order or position along that edge.

## ATTACKER

The Attacker is the Command Company of Cranston Snord's Irregulars. All of their BattleMechs are in good condition.

### First (Command) Company

#### Command Lance

Colonel Cranston Snord (*Piloting 1, Gunnery 2*), *Archer*  
 Lieutenant Deb H'Chu (*Piloting 2, Gunnery 1*), *Thunderbolt*  
 David Rowsch (*Piloting 5, Gunnery 3*), *Marauder*  
 John Malvinson (*Piloting 4, Gunnery 3*), *Wasp*

#### Attack Lance

Lieutenant Marcos Shake (*Piloting 3, Gunnery 1*), *Catapult*  
 Tempest Storm (*Piloting 5, Gunnery 5*), *Centurion*  
 Anthony Pryor (*Piloting 5, Gunnery 4*), *Orion*  
 Clame McDonald (*Piloting 3, Gunnery 2*), *Victor*

#### Recon Lance

Lieutenant Winston Nearon (*Piloting 2, Gunnery 2*), *Locust*  
 Betty Orzenchi (*Piloting 5, Gunnery 5*), *Ostscout*  
 Cyndos Thomlinson (*Piloting 4, Gunnery 6*), *Spider*  
 Arnold Ling (*Piloting 4, Gunnery 4*), *Jenner*

### Deployment

The Attacker sets up before play anywhere on the north map, within six hexes of the north edge.

## VICTORY CONDITIONS

The scenario lasts 20 turns. Cranston Snord's Irregulars are awarded points for exiting BattleMechs off of the south edge of the south map within that time.

### VICTORY TABLE

Number Irregulars 'Mechs Exited	Result
0	Decisive Marik Victory
1-3	Marginal Marik Victory
4-6	Marginal Irregulars Victory
6+	Decisive Irregulars Victory

## SPECIAL RULES

A low, heavy fog lies directly over Lake Fairfield (on the north map), and there is no wind. This blocks line-of-sight across the lake. Treat the fog as Level 1 Heavy Woods terrain for line-of-sight and combat purposes.

One of the pivotal regions of space contested during the Fourth Succession War was the Tikonov Free Republic. Pavel Ridzik turned to the Federated Suns and both the Lyran Commonwealth and the Tikonov Republic pushed to gain worlds in the Terran Corridor, posing a great threat to the Free Worlds League: for the first time ever it stood virtually cut off from Terra.

As the fledgling Tikonov Republic forces prepared for their mid-3029 assaults on Procyon and Wasat, the Lyran Commonwealth pressed several mercenary units into committing raids along the Tikonov/Terran/Free Worlds League corridor. The goal was simply to keep the Free Worlds League military busy while Ridzik prepared for his key assaults.

Cranston Snord learned of these plans during the winter of 3028-29 and immediately began to research the targeted worlds. Bordon stood out for a number of reasons. One, it was only lightly defended at the time, according to intelligence. Two, it held importance to the Marik Militia because of their historical defense of the world.

Third, and probably most important to Cranston Snord, was the report he received from an antique dealer who had visited Frankenmuth, Bordon's capital city, several months before the outbreak of war. According to the report, the Aramis Throne was tucked away in a musty little museum. This was the throne that Stefan Amaris, the Usurper, had shipped from the Rim Worlds League after his successful coup on the Star League. Cranston wanted it for his museum on Clinton.

While Rhonda and the Third Company secured the landing zone and Shorty led a diversionary attack, Cranston led the First Company to Frankenmuth. At the shores of Lake Fairfield, he encountered a company of the Thirteenth Marik Militia. Snord used the lake to increase his firepower against the Militia, and turned the lake and its thick fog cover into deadly weapons against his enemies.

When the Marik Militia guessed that his goal was Frankenmuth and moved to block his way, Cranston launched an all-out running attack against his already weakened enemy.

As of 3051, the Aramis Throne resides in a specially sealed glass case in the Clinton museum, testimony to a madman and proof positive of the creativity of its current owner.



# FAREWELL TO A FRIEND

## FALLEN COMRADE

Cranston and the rest of the battalion bowed their heads at the grave of Shalimar Windall. Blade stood beside Cranston, draped in black, silently mourning the loss of her father.

The mercenary commander put his hand on her shoulder and began.

"In all my years as commander, this is the one duty that I have most come to hate, saying goodbye to a fallen comrade. Shalimar Windall, we are all lessened by your absence.

"Shalimar was a man who kept to himself and his family. Those of us he did confide in know that he rose from the ranks of the Dispossessed and fought with distinction. He faced death several times, but, like the rest of us, had cheated the grim reaper. It cost him both his legs and his arms. Still Shalimar did not feel sorry for himself. He lived to fight on and raise an outstanding MechWarrior who will carry on his good name and proud tradition.

"When we landed on Connaught, I did not expect this to happen.

"Indeed, we would have avoided a fight altogether if not for the Silver Hawks. While we made good our escape, Shalimar remained to protect our retreat. Outnumbered ten to one, he stayed so that the rest of us might live.

"Sacrifice is something all battle commanders have to accept at one time or another: the men and women who throw themselves on grenades or take a shot meant for another. Shalimar's sacrifice was to save the Irregulars, and for that we all owe him a great deal—our lives.

"We shall remember you always, old friend, and we know that your action will inspire us when times get tough."

Cranston reached down, took a handful of soil, and tossed it into the grave on top of the Commonwealth flag draping the coffin. Seven of the Irregulars fired off their slug-throwers three times in succession. Twenty-one guns in salute to a hero. Some traditions never change.

## GAME SET-UP

Lay out the **BattleTech** maps as shown.

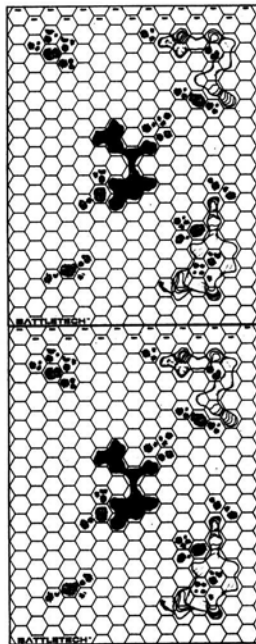

### DEFENDER

The Defender consists of combined elements of Snord's Irregulars Command Lances engaged in a rear-guard action.

#### First (Command) Company

##### Command Lance

Colonel Cranston Snord (*Piloting 1, Gunnery 2*), Archer  
Lieutenant Deb H'Chu (*Piloting 2, Gunnery 1*), Thunderbolt  
David Rowsch (*Piloting 5, Gunnery 3*), Marauder  
John Malvinson (*Piloting 4, Gunnery 3*), Wasp

#### Second Company (Shorty's Scavengers)

##### Command Lance

Captain Samuel "Shorty" Sneede (*Piloting 1, Gunnery 1*), Rifleman  
Lieutenant Jake Walmar (*Piloting 2, Gunnery 2*), Warhammer  
Marleen Danules (*Piloting 5, Gunnery 5*), Clint  
Carter Malvinson (*Piloting 6, Gunnery 5*), Phoenix Hawk

#### Third Company (Rhonda Snord's Irregulars)

##### Command Lance

Captain Rhonda Snord (*Piloting 2, Gunnery 2*), Shadow Hawk  
Lieutenant Terry Malvinson (*Piloting 3, Gunnery 3*), Phoenix Hawk  
Shalimar Windall (*Piloting 2, Gunnery 2*), Crusader  
Walker Roche (*Piloting 4, Gunnery 6*), Griffin

### Deployment

Defender enters along the north edge of the north map at the beginning of Turn 1.

## ATTACKER

The Attacker is the Command Company of the Silver Hawk Irregulars' Second Regiment, the Gryphons.

### First (Command) Company

#### Command Lance

Captain Martha Zuritas (*Piloting 2, Gunnery 1*), *Marauder*  
 Lieutenant Inga Verster (*Piloting 3, Gunnery 2*), *Hermes II*  
 Fasha Sivis (*Piloting 2, Gunnery 4*), *Catapult*  
 Sergeant Victo Franz (*Piloting 3, Gunnery 3*), *Hatchetman*

#### Strike Lance

Lieutenant Jimm Lillibrigg (*Piloting 4, Gunnery 3*), *Quickdraw*  
 William Griffiphs XXI (*Piloting 3, Gunnery 2*), *Archer*  
 Boris Dagin (*Piloting 5, Gunnery 3*), *Warhammer*  
 Candy Shakos (*Piloting 2, Gunnery 4*), *Catapult*

#### Scout Lance

Lieutenant Diane Doubleu (*Piloting 1, Gunnery 1*), *Cicada*  
 Sergeant Johnny Knoxx (*Piloting 2, Gunnery 4*), *Enforcer*  
 Ivar Spallis (*Piloting 3, Gunnery 4*), *Assassin*  
 Rusty Anderbon (*Piloting 4, Gunnery 4*), *Ostscout*

## Deployment

Starting on Turn 2, roll 1D6 for each of the Silver Hawk lances. On a roll of 4–6, that lance may enter that turn. All Silver Hawk 'Mechs enter on the north edge of the north map (chasing the Defender).

## VICTORY CONDITIONS

Points are awarded for various actions and activities in this scenario. The side with the most points at the end of 15 turns is the winner. Points are awarded as follows:

### Attacker

Points	Action
5	Each Defender's 'Mech destroyed or disabled
2	Each Defender's 'Mech (other than Shalimar Windall's) on the map at the end of Turn 15

### Defender

Points	Action
4	Each Defender's 'Mech exited over the south edge of the south map
1	Each turn after Turn 5 that Shalimar Windall's 'Mech is able to move or fire

## SPECIAL RULES

Shalimar Windall may not leave the north map, regardless of the actions of the rest of Snord's Irregulars.

Snord's Irregulars' successful raid on Bordon pressured the Free Worlds League into committing several battalions to the planet as garrisons against future attacks. Each such raid forced House Marik to tie down more troops needed against the attacks by the Tikonov Republic along the Terran Corridor.

Cranston selected Connaught as a target for several reasons. It was believed to have only a non-'Mech garrison, which would make it an easier target. Furthermore, it was deep enough in the Free Worlds League that House Marik would be forced to commit even more reserves to garrison duty.

Lastly, as should be expected, a joint ComStar/Free Worlds archaeological dig had unearthed the remains of a bank. Within its ruins was a collection of coins, some dating back over two thousand years. Apparently the bank and much of the surrounding countryside had been obliterated during one of the Succession Wars.

However, Cranston's usually flawless intelligence had failed to notice that the Silver Hawk Irregulars had been stationed there, preparing for transfer to the Republican front lines.

Snord's Irregulars deployed with little difficulty and managed to liberate the coin collection from the bewildered archaeologists. In the meantime, the Gryphons moved into position, hoping to overtake Snord's Irregulars before they made it back to their DropShips. The Gryphons sprung their trap among the rocky slopes of the Brass Hills. Snord's Irregulars fought a running battle, realizing that they were outnumbered. Even while in flight, they were slowly being worn down by long-range shots.

At the peak of the fire fight, Cranston gave the order to retreat the last five kilometers to the ships. Despite orders to the contrary, Shalimar Windall remained. Standing alone, he tied down the Silver Hawk Gryphons long enough for the remaining Irregulars to launch.

At the end of the war, the Silver Hawk Irregulars arranged to have Shalimar's remains returned to Clinton for burial.

# FISTFUL OF CRYSTALS

## THE WACO BLUNDER

—Interview with Cyndos Thomlinson, from "Mercenaries of the Inner Sphere," a documentary produced by the Donegal Broadcasting Company.

DBC: As I understand it, this whole mission was to recover a collection of priceless crystal, correct?

THOMLINSON: Yes and no. Colonel Waco has it in for anyone associated with Wolf's Dragoons, especially after his son died in action against them. Well, Cranston is supposed to have served with the Dragoons back when they first came into the Inner Sphere. Waco said that if we didn't come and face him, he would destroy the collection—just out of spite.

DBC: How did you pull off the raid?

THOMLINSON: Instead of stumbling into the Ranger's trap, Colonel Snord came up with a plan.

We borrowed several commercial Drop-Haulers and used those to land, while our DropShips moved into orbit. So Waco's boys thought we were someplace else. While they tried to pin down the DropShips' LZs, we hit the city of Thule and heisted the crystal.

DBC: It wasn't that easy, though, was it?

THOMLINSON: Of course not. Just when we thought we were clear, two scout lances stumbled over us. The command lance was right on top of them before they broke and tried to warn the rest of their unit. Rhonda jammed their transmissions and a handful of us moved in to cut them off.

DBC: It must take a great deal to knock out BattleMechs making a break for it.

THOMLINSON: You don't know the half of it. I squared off facing two *Jenners* and a *Wasp*. My right leg got melted. I jumped twice and had my right arm blown off. I managed to put what was left of my right leg into the cockpit of a *Jenner*, though.

I was grounded but functional. The other *Jenner* turned away from me and I cut through his rear armor—he never knew what hit him.

Our lance commander, Lieutenant Nearon, made a quick business out of them in his *Locust*.

Some of their heavies closed in as Walker finished off the last *Javelin*, but he was still up and running. They broke our jamming and called for reinforcements. Thank the gods the Third Company arrived when they did, or I would have been toast.

## GAME SET-UP

Lay out the BattleTech maps as shown.

N

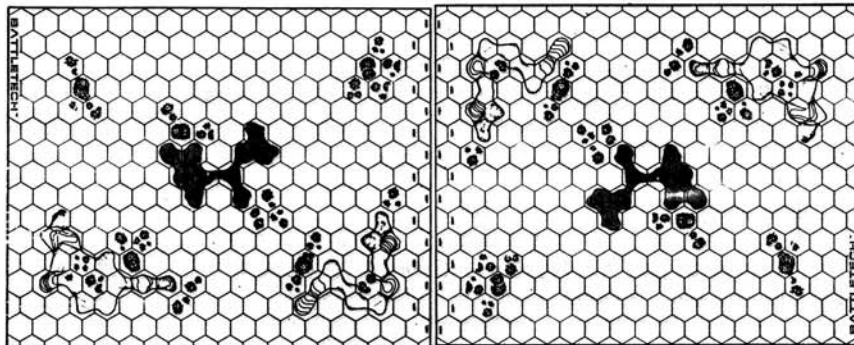

## DEFENDER

The Defender consists of elements of the Command and Third Companies of Snord's Irregulars. Reinforcements are from the Third company of Snord's Irregulars. All 'Mechs are in good condition.

### First Recon Lance (ad-hoc)

Lieutenant Winston Nearon (*Piloting 2, Gunnery 2*), *Locust*  
Cyndos Thomlinson (*Piloting 4, Gunnery 6*), *Spider*  
Walker Roche (*Piloting 4, Gunnery 6*), *Griffin*

### Third Company (Rhonda Snord's Irregulars)

Captain Rhonda Snord (*Piloting 2, Gunnery 2*), *Shadow Hawk*  
Lieutenant Terry Malvinson (*Piloting 3, Gunnery 3*), *Phoenix Hawk*  
Blade Windall (*Piloting 4, Gunnery 4*), *Warhammer*  
Victoria Rose (*Piloting 4, Gunnery 4*), *Awesome*

## Deployment

On Turn 2, any two BattleMechs of the Recon Lance may enter on the west map, along the north, west, or south edges. They are not required to enter along the same edge.

On Turn 4, the remaining BattleMech of the Recon Lance may enter on the west map, along the north, west, or south edge.

On Turn 5, the Third Company may enter on the east edge of the east map.



**ATTACKER**

The Attacker consists of elements of Kelly's Support Battalion, Winston's Scout Lance, and Kristi's Scout Lance, Waco Rangers.

**Waco Rangers**

Lieutenant D.D. Winston (*Piloting 3, Gunnery 3*), *Javelin*  
 Sergeant Anita Chu Lai (*Piloting 5, Gunnery 4*), *Javelin*  
 Joe "Mr. X" Zeek (*Piloting 5, Gunnery 4*), *Jenner*  
 Joe Don Hoe (*Piloting 5, Gunnery 3*), *Jenner*  
 Donna de la Kalbe (*Piloting 2, Gunnery 3*), *Wasp*

**Deployment**

The Attacker enters along the east edge of the east map at the beginning of Turn 1.

**VICTORY CONDITIONS**

The two goals of the Waco Rangers are to inflict damage and to get away from the Irregulars so they can warn the rest of their regiment. The scenario lasts 12 turns. At that time, points are assigned to the Waco Rangers in the following way:

Points	Action
6	Each Rangers' BattleMech exited off the west edge of the western map
2	Each Rangers' BattleMech on the map capable of movement
3	Each Irregulars' BattleMech destroyed
-4	Each Rangers' BattleMech destroyed or unable to move

**VICTORY TABLE**

Points	Result
18+	Rangers' Decisive Victory
9-17	Rangers' Marginal Victory
6-8	Draw
0-5	Irregulars' Marginal Victory
<0	Irregulars' Decisive Victory

Janos Marik developed a deep hatred for Cranston Snord and his Irregulars over the years. At one time he had successfully pillaged their museum on Clinton, only to have the Irregulars raid the Free Worlds League for weeks, recovering what was stolen. Assassination attempts against the mercenary had all failed. Janos had been humiliated time and again by the small band of mercenaries.

In 3032, Janos devised a new tactic. Using the reputed links between the Irregulars and Wolf's Dragoons, Marik convinced Wayne Waco of Waco Rangers to lure the Irregulars into a battle, playing on Waco's hatred of the Dragoons. Marik hoped the Irregulars would be destroyed. Blinded by his hate, Waco went along with Marik's plans, and sent a challenge to Snord. If the Irregulars did not come and face off against an equal number of Rangers, Waco would destroy a priceless collection of Demmings crystal. The dueling ground was to be on Nockatunga, 30 kilometers from Thule.

Cranston discovered that the entire Rangers regiment, not just a company, had dug in on the planet. Sneaking onto the world in captured merchant DropShips, his infantry entered Thule and liberated the bait from the trap. Communications out of the city were cut off by the Irregulars' Mechs. Meanwhile, the Irregulars' DropShips moved into position on the far side of the central continent to draw away most of the Rangers.

Elements of Winston's Scout Lance spotted the Irregulars' BattleMechs in Thule. This unit made a fast break to get out of the Irregulars' jamming range. Their break took them right to three Irregulars BattleMechs.

The three 'Mechs engaged the fast-moving reconnaissance unit to prevent its escape. Meanwhile, Rhonda Snord and her support battalion closed in on the unit from the rear. Despite heroic efforts on the part of the Irregulars, one BattleMech escaped, warning Colonel Waco that Snord's Irregulars had arrived.



# A FEW CRYSTALS MORE

## AN OLD MAN'S HATE

"Remember, I want Snord alive."

"Yes sir, Colonel Waco, sir," replied Lieutenant Wernke.

Major Noble signaled. "I'm picking up some occasional electro-mag discharge to the south."

"All right, ladies and gents," Colonel Wayne Waco began. He was proud of having forced Snord's hand. "Snord and his boys don't know we're here. I have the whole regiment moving in, but it's up to us to hold them down till help can arrive. When we make contact, Lieutenant Sanchuie will take his lance and move hard to flank us on the north. We should surround them."

"Blips to the south, sir," came back Major Noble. "Confirmed at least one BattleMech, class unknown, moving at 189 point 2."

"Sir, Bunkerara here. I'm showing a fast-moving bogie to the east at 92 point 5."

Captain Randall overrode the channel, "Colonel, I got bogies to the west. Multiple 'Mechs, all heavies..."

Suddenly a voice boomed on the Rangers' command frequency. "Colonel Waco, I presume?" Cranston Snord asked snidely.

"Snord..." Waco choked out.

"I appreciate the comment about taking me alive. However, I believe that you are surrounded. I would grant you the opportunity to surrender, but I know this fight means too much to you."

"Blast you, Snord. You'll regret the day you admitted being kin to that Jaime Wolf!" Rage filled the old man's voice.

Loud music, something about a hound dog, blared, and Rhonda Snord and her Command Company opened fire.

\* \* \*

Colonel Waco pulled a shard of cockpit glass out of his scalp. His trademark ten-gallon hat lay somewhere in what remained of his *BattleMaster's* cockpit. Dazed, he heard a voice from outside.

"It's over, Colonel Waco," Snord said. "You challenged us and lost. We beat you at your own game."

Waco stared up at the *Archer* only ten yards away. "Come on, Snord, kill me. Show the world you're just like Wolf. Be a man, fire if you've got the guts."

## GAME SET-UP

Lay out the **BattleTech** maps as shown.

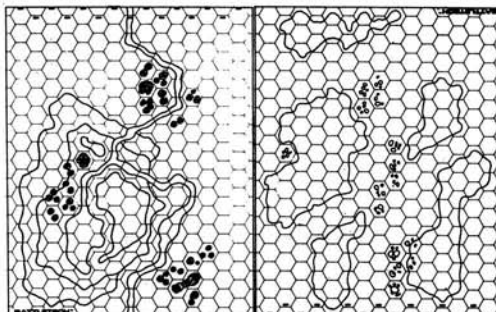

## DEFENDER

The Defender is Colonel Wayne Waco and his regimental Command Lance, as well as elements of Noble's Headquarters Company of the Waco Rangers. All of their 'Mechs are in good condition.

### Waco's Command Lance

Colonel Wayne Waco (*Piloting 1, Gunnery 2, BattleMaster*)  
Captain Akida Samsun (*Piloting 3, Gunnery 2, Marauder*)  
Captain Reggie Randall (*Piloting 2, Gunnery 4, Wasp*)  
Sergeant Lenny Markbright (*Piloting 3, Gunnery 3, Cyclops*)

### Noble's Headquarters Company

#### Noble's Command Lance

Major Paulus Noble (*Piloting 1, Gunnery 2, Banshee*)  
Captain Jorge Delphinus (*Piloting 2, Gunnery 3, Cyclops*)  
Lieutenant Daverius Bunkerara (*Piloting 4, Gunnery 3, Quickdraw*)  
Lieutenant Marcus Aeolus Wernke (*Piloting 1, Gunnery 3, Warhammer*)

#### Sanchuie's Scout Lance

Lieutenant Troy Sanchuie (*Piloting 1, Gunnery 4, Javelin*)  
Sergeant Eric Long (*Piloting 4, Gunnery 4, Javelin*)  
"Jolly Jim" Smith (*Piloting 3, Gunnery 4, Locust*)  
Anita Michei (*Piloting 2, Gunnery 5, Locust*)

## Deployment

The Waco Rangers set up before the start of play anywhere within six hexes of Hex 0810 on the east map.

## ATTACKER

The Attacker consists of all three command lances and the Third Company's fire lance of Snord's Irregulars.

### First (Command) Company

#### Command Lance

Colonel Cranston Snord (*Piloting 1, Gunnery 2, Archer*)  
Lieutenant Deb H'Chu (*Piloting 2, Gunnery 1, Thunderbolt*)  
David Rowsch (*Piloting 5, Gunnery 3, Marauder*)  
John Malvinson (*Piloting 4, Gunnery 3, Wasp*)

**Second Company (Shorty's Scavengers)**

**Command Lance**

Captain Samuel "Shorty" Snee (Piloting 1, Gunnery 1), Rifleman  
 Lieutenant Jake Walmar (Piloting 2, Gunnery 2), Warhammer  
 Marleen Danules (Piloting 5, Gunnery 5), Clint  
 Carter Malvinson (Piloting 6, Gunnery 5), Phoenix Hawk

**Third Company (Rhonda Snord's Irregulars)**

**Command Lance**

Captain Rhonda Snord (Piloting 2, Gunnery 2), Shadow Hawk  
 Lieutenant Terry Malvinson (Piloting 3, Gunnery 3), Phoenix Hawk  
 Walker Roche (Piloting 4, Gunnery 6), Griffin  
 Victoria Rose (Piloting 4, Gunnery 4), Awesome

**Fire Lance**

Lieutenant Bright Thomlinson (Piloting 2, Gunnery 1), Rifleman  
 Solomon Storm (Piloting 2, Gunnery 3), Wolverine  
 Linda Thomlinson (Piloting 6, Gunnery 3), Scorpion  
 Blade Windall (Piloting 4, Gunnery 4), Warhammer

**Deployment**

On Turn 1:  
 First Company's Command Lance enters on the north edge of the east map,  
 Second Company's Command Lance enters on the south edge of the east map,  
 Third Company's Command Lance enters on the east edge of the east map, and  
 Third Company's Fire Lance enters on the west edge of the west map.

**VICTORY CONDITIONS**

Snord's Irregulars are awarded points for their actions in the battle. At the end of 15 turns, the points are tallied and compared against the **Victory Table**.

Points	Action
6	Colonel Wayne Waco's 'Mech destroyed or unable to move
3	All other Rangers' 'Mechs destroyed or unable to move
-4	All Irregulars' 'Mechs destroyed or unable to move
-5	Colonel Waco's 'Mech exited off the west edge of the west map
-4	All other Rangers' 'Mechs exited off the west edge of the west map

**VICTORY TABLE**

Points	Result
11 or more	Irregulars Decisive Victory
5 to 10	Irregulars Marginal Victory
-1 to 4	Draw
-2 to -16	Ranger Marginal Victory
-16 or less	Ranger Decisive Victory

**SPECIAL RULES**

Treat all water or stream hexes as Level 0 clear terrain.

The Irregulars knew that the Waco Rangers had been tipped off to their presence. The carefully staged trap that Colonel Waco had set had begun to unravel almost from the start, but he was unaware of that fact. The Irregulars' technicians had managed to recover the cockpit communication codes from one of the Ranger 'Mechs downed near Thule and so Cranston knew that Colonel Wayne Waco was personally leading the reconnaissance to find Snord's unit.

Using their own satellite for bounce-back coordinates, Cranston was able to pinpoint the exact location of all the Rangers' BattleMechs. He carefully moved two companies of his own forces into position to encircle Colonel Waco. Cranston knew that if Waco were killed or captured, the Irregulars stood a far better chance of avoiding pursuit by the rest of the Rangers.

Noble's Command Company and Waco's Command Lance found themselves trapped in the hills twelve kilometers from Thule. Isolated from the rest of the regiment, the Rangers were surrounded and attacked. With little room to maneuver, the Rangers began to fall.

At the end of the battle, Colonel Waco's *BattleMaster* crumbled, its legs shot out from under it in a hail of gunfire. Face to face with his foe, Cranston spared the mercenary commander, despite (some say) his better judgment.



# EVERYTHING OLD IS NEW

## INITIATION OF THE NEW IRREGULARS

"Did I mention that I hate Vega?" Anthony repeated as he ran another scan of the area.

"Only every other minute," Tempest Storm replied.

"Can the chatter, you two," fired back the usually easy-going Lieutenant Shake. "My T&T system is picking up some faint motion in the far ranges."

"Marcos, this is Rhonda. Rowsch and Wayne both have confirmed tracking on Kurita 'Mechs. Looks like more than a company. Repeat, we have confirmed snakes."

"Orders, Colonel?" came the voice of Lieutenant Darrell Lanst, piloting the Irregulars' Padilla near the rear of the unit.

Before she could reply, a volley of long-range missiles rained around her *Highlander*. Two hit their mark, shaking the old 'Mech, but it held its position, testimony to its quality construction.

"Park it where you are, Lanst, and give us fire support. Have the rest of the ground-pounders in the support lance cut to the right flank."

Rhonda paused long enough to target her Gauss rifle. A deep thudding noise rose from the barrel as heavy silver slugs slammed into the cockpit of a Kurita *Catapult*. The 'Mech stopped in its tracks, swayed for a moment, then fell.

"Wayne, you and Tempest get to the flank. Coordinate fire with Lanst's Padilla. The rest of you run an E1, that's Epsilon One, formation." A volley of short-range missiles peppered the right leg of her *Highlander* as she finished speaking. They mauled the armor plating, but didn't penetrate. Rhonda pivoted and locked onto the *Warhammer* that was racing past her toward the rest of the attack lance.

Lieutenant Shake's *Bombardier* quickly targeted one of the Kurita 'Mechs. His 'Mech shuddered under a hail of autocannon fire as he let go two volleys of long-range missiles against the enemy *Shadow Hawk*. Almost all of the 40 missiles pounded into the Draconis BattleMech, covering it in a cloud of shrapnel, smoke, and electrical discharge. "Any other orders, Colonel?"

A blast of music filled the comm-channel. He heard Rhonda over the roar. "Yeah, Shake-man, hit them before they hit us!"

## GAME SET-UP

Lay out the **BattleTech** maps as shown.

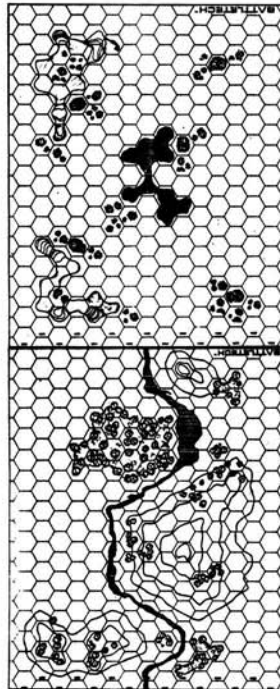

### DEFENDER

The Defender consists of elements of the Snord's Irregulars Battalion. All of their BattleMechs and vehicles are in good condition.

#### First (Command) Company, Rhonda Snord's Irregulars

##### Command Lance

Colonel Rhonda Snord (*Piloting 2, Gunnery 1*), *Highlander*  
Dennis Maltesta (*Piloting 2, Gunnery 2*), *Excalibur*  
David Rowsch (*Piloting 3, Gunnery 2*), *Guillotine*  
Sharonus Wayne (*Piloting 3, Gunnery 2*), *Spartan*

##### Attack Lance

Lieutenant Marcos Shake (*Piloting 2, Gunnery 1*), *Bombardier*  
Tempest Storm (*Piloting 3, Gunnery 2*), *Spartan*  
Anthony Pryor (*Piloting 3, Gunnery 1*), *Lancelot*  
Charlotte Deblois (*Piloting 3, Gunnery 1*), *Thug*

#### Second Company (Shorty's Scavengers)

##### Support Lance

Lieutenant Darrell Lanst (*Piloting 3, Gunnery 3*), Padilla Artillery Tank  
Dorchester Quinn (*Piloting 4, Gunnery 2*), Burke Heavy Tank  
Archie Ferris (*Piloting 4, Gunnery 1*), Demon Armored Car  
Nathan "Beaver" Hauck (*Piloting 2, Gunnery 3*), Rotunda Scout Car

**Third Company****Support Platoons (Anti-'Mech Trained)**

Lieutenant Fasha Nagaraj, Elite  
 Sergeant Baca Tsaprazis, Veteran, Jump Infantry (Laser)  
 Sergeant Nanette Warkentin, Regular, Motorized Infantry (SRM)  
 Sergeant Roger H'Chu, Veteran, Infantry (SRM)  
 Corporal Darwin "Breaker" Morgan, Elite, Motorized Infantry (Laser)

**Deployment**

The elements of the First and Third Companies may set up anywhere on the north map at least eight hexes from the north edge before the start of play. The Second Company Support Lance may set up anywhere on the south map at least ten hexes from the south edge before the start of play.

**ATTACKER**

The Attacker consists of advance elements of the Fifth Amphigean Light Assault Group's Third Battalion, Command Company. All their BattleMechs are in good condition.

**Command Company****Command Lance**

*Chu-sa Fengo Olesko (Piloting 2, Gunnery 3), Warhammer*  
*Abusan Frazer (Piloting 1, Gunnery 4), Catapult*  
*Keith Bentilson (Piloting 2, Gunnery 2), Dragon*  
*Sabu Kann (Piloting 3, Gunnery 4), Grasshopper*

**Fire Lance**

*Chu-i Ronn Bewrow (Piloting 2, Gunnery 1), Grand Dragon*  
*Eillen Maccartisoorn (Piloting 3, Gunnery 4), Phoenix Hawk*  
*Bee Kai (Piloting 4, Gunnery 4), Panther*  
*Shree Breknoth (Piloting 2, Gunnery 4), Vulcan*

**Scout Lance**

*Chu-i Joe Tawbitz (Piloting 2, Gunnery 2), Clint*  
*Dagga Fex (Piloting 4, Gunnery 3), Stinger*  
*Streeda Dent (Piloting 5, Gunnery 2), Locust*  
*Theresa Marisoorn (Piloting 3, Gunnery 4), Locust*

**Deployment**

On Turn 1, the Command Lance enters on the north edge of the north map. On Turn 2, the Fire Lance enters on the north edge of the north map. On Turn 4, the Scout Lance enters on either the north, east, or west edge of the north map.

**VICTORY CONDITIONS**

The Attacker wins by destroying at least three Irregulars BattleMechs and exiting at least five of its own 'Mechs off the south edge of the south map by Turn 20. Any other outcome is a victory for the Defender.

**SPECIAL RULES**

Use the optional **Anti-BattleMech Infantry** rules in the **BattleTech Compendium** (pp. 47–8). Also, the SRM-armed infantry of Snord's Irregulars are equipped with optional **Infernos** (p. 60).

The War of 3039 was a see-saw series of fights similar to those of the First and Second Succession Wars. Taking Vega was one of the Federated Commonwealth's priorities, and Snord's Irregulars were included in the initial landings, along with elements of the First Grave Walkers.

This was the first test of Rhonda Snord's new command, fully refitted and re-equipped with Star League BattleMechs and vehicles recovered on Phecda and Volders. Although the Irregulars had trained with these weapons, this was their first chance to use them in real combat.

Near the Bandlisi Pyramid, in a hilly, rough area known locally as the Bandli Wastes, Snord's Irregulars encountered the advance elements of the Fifth Amphigean Light Assault Group's Third Battalion, under the command of young *Chu-sa Fengo Olesko*. This unit had been harassing F-C troops for several days, and the Irregulars were appointed to hunt down and destroy it.

The Irregulars' Star League equipment and vehicles gave them several edges. At the first contact with the Fifth, Rhonda used the Arrow missile system on the Padilla tank in conjunction with her *Spartan* BattleMechs. This gave her units quick fire support, something her Combine counterparts did not have. In addition, the anti-missile systems on many of the 'Mechs seemed to catch the Kurita attackers off guard. Finally, the durability and heat-venting capabilities of the SLDF BattleMechs allowed them to stay in a fight much longer.

The battle only lasted 40 minutes. Half the Combine battalion was destroyed or disabled, with the rest driven into retreat. *Chu-sa Olesko* survived the battle, carried off by one of her fellow warriors.

She recovered and was later transferred off-world just before Vega's full occupation by Federated Commonwealth forces. She would return as part of the Second Legion of Vega during its daring counteroffensive to regain Vega for the Combine.

# STORM'S END

## A TIME TO DIE

—From the personal journal of Tempest Storm, Attack Lance, Snord's Irregulars, 31 July 3039

Our pilots had scanned the area and painted us a pretty bleak picture. The entire Second Legion of Vega was sitting out there, making its way toward us. Frankly, we were all a little worried, but Father looked like he had something else on his mind.

I asked him what was wrong and he simply adjusted his ten-gallon hat and smiled. Then he handed me his bullwhip. He didn't say a word, just handed me his most prized possession.

Rhonda had us deployed in a staggered formation smack-dab in the middle of the Combine advance. Our goal was to punch a hole through the Kurita 'Mechs and make a run to their rear. It seemed simple enough, but we all knew the risks.

My lance had point when we made contact. In came our fighters, strafing the Combine 'Mechs as they dove for cover. My father's lance was on the far right flank and they caught the brunt of the Dragon counterattack. I had my own problems, but I remember seeing him struggling with a *Grand Dragon*, literally ripping it to shreds as it tried to close with him. With each step, the *Grand Dragon* seemed to melt away as Father's missiles tore into it.

I was hit hard by a rain of SRM fire and I turned away. Sharonus took a good pounding of LRMs until she managed to make her way into some heavy forest. I was becoming more and more concerned about my father, but I had to fight my own battle. I kicked a *Panther* away, and when I turned again, Father was standing on the remains of a *Wasp*, facing a Kurita *Goliath*.

He walked up to it, his guns and missiles blazing away. I saw the PPC fire from the *Goliath* hit his cockpit. There was a pause, then he charged into the *Goliath*. The next shot cut right through what was left of his armor, and his *Sentinel* disappeared when the reactor dropped its shield and melted.

The Combine troops broke in our sector, only to regroup and kick the rest of the planet's garrison two days later. We had won our fight, but I had lost Father. I wonder how he knew he was going to die. I hope I am as brave at the end as he was.

## GAME SET-UP

Lay out the **BattleTech** maps as shown.

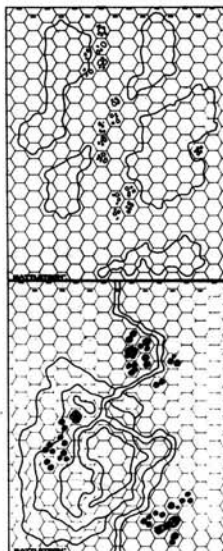

### DEFENDER

The Defender is the Second Legion of Vega, Second Battalion, Command Company.

#### Command Company (Olesko's Samurai)

##### Command Lance

*Tai-sa* Fengo Olesko (*Piloting 2, Gunnery 2*), *Atlas*  
*Tai-i* Ferrison Grabrial (*Piloting 2, Gunnery 4*), *Archer*  
*Chu-i* Dakara Singh (*Piloting 4, Gunnery 2*), *Goliath*  
Yammen Teris (*Piloting 4, Gunnery 3*), *Dragon*

##### Attack Lance

*Chu-i* Lydia Baker (*Piloting 4, Gunnery 1*), *Grand Dragon*  
Pace Reederson (*Piloting 5, Gunnery 4*), *Ostroc*  
Daido Trent (*Piloting 3, Gunnery 4*), *Orion*  
Keiper Vancer (*Piloting 4, Gunnery 2*), *Dervish*

##### Sweep Lance

*Chu-i* Drekker Neece (*Piloting 4, Gunnery 2*), *Panther*  
Carter Yols (*Piloting 4, Gunnery 5*), *Wasp*  
Tango Holt (*Piloting 5, Gunnery 3*), *Locust*  
Severin Faslt (*Piloting 3, Gunnery 4*), *Cicada*

### Deployment

The Defender must set up the Command Lance within 8 hexes of the north edge of the north map. The Attack Lance must be set up within 3 hexes of the east edge of the north map, and the Sweep Lance must be set up within 3 hexes of the west edge of the north map.

## ATTACKER

The Attacker consists of elements of the Snord's Irregulars Battalion. All their BattleMechs are in good condition.

### First (Command) Company, Rhonda Snord's Irregulars

#### Command Lance

Colonel Rhonda Snord (*Piloting 2, Gunnery 1, Highlander*)  
 Dennis Maltesta (*Piloting 2, Gunnery 2, Excalibur*)  
 David Rowsch (*Piloting 3, Gunnery 2, Guillotine*)  
 Sharonus Wayne (*Piloting 3, Gunnery 2, Spartan*)

#### Attack Lance

Lieutenant Marcos Shake (*Piloting 2, Gunnery 1, Bombardier*)  
 Tempest Storm (*Piloting 3, Gunnery 2, Spartan*)  
 Anthony Pryor (*Piloting 3, Gunnery 1, Lancelot*)  
 Charlotte Deblois (*Piloting 3, Gunnery 1, Thug*)

### Second Company (Shorty's Scavengers)

#### Air Lance

Lieutenant Richter Nikmen (*Piloting 3, Gunnery 2, Rapier*)  
 Travis Horr (*Piloting 3, Gunnery 3, Ironsides*)  
 Yolinda Brekner (*Piloting 4, Gunnery 2, Gotha*)

### Third Company

#### Fire Lance

Lieutenant Bright Thomlinson (*Piloting 2, Gunnery 1, Crockett*)  
 (3037-39) Solomon Storm (*Piloting 2, Gunnery 2, Sentinel*)  
 Linda Thomlinson (*Piloting 4, Gunnery 1, Flashman*)  
 Blade Windall (*Piloting 1, Gunnery 2, Highlander*)

#### Deployment

The Attacker's BattleMechs must set up anywhere within 4 hexes of the south edge of the south map. The Irregulars' Air Lance is available at the start of Turn 3 (and may announce an attack during the Turn 3 Attack Phase), per the **Strafing** rules.

## VICTORY CONDITIONS

The scenario lasts 24 turns. At that time, points are awarded to players in the following manner. The player with the most points at the end of 24 turns is the winner:

### VICTORY TABLE

#### Attacker

Points	Action
3	Each BattleMech exited off the north edge of the north map
2	Each enemy BattleMech destroyed or unable to move or fight
1	Each BattleMech on the north map and functional at the end of Turn 24

#### Defender

Points	Action
3	Each enemy BattleMech destroyed or unable to move or fight
2	Each AeroSpace fighter destroyed

## SPECIAL RULES

Treat all woods on the south map board as Heavy Woods.

Treat all streams or rivers as Level 0 Clear Terrain.

Use the **AeroTech Strafing** rules in the **BattleTech Compendium** (pp. 96-7) for the Irregulars' fighters.

The War of 3039 saw an initial Federated Commonwealth thrust and a stunning counterattack by the highly organized forces of Theodore Kurita. Vega, a key world in the Dieron Military District, was considered vital to any Combine counterattack. Although the Federated Commonwealth forces were keenly aware of this fact, they did not know how far the Draconis Combine Military was willing to go in order to retake the planet.

Operations began on 12 July when a DEST team of commandos launched an assassination attempt against Field Marshal Nondi Steiner and her Vega garrison command staff. That same day the Second Legion of Vega appeared in full force at a pirate jump point and immediately began landing operations.

With its command staff either dead or disorganized by the assassination attempt, the Federated Commonwealth forces were ill-equipped to deal with the counterattack by the Second Legion. The DEST operatives crippled all local communications systems as well, making it nearly impossible for the garrison command to transmit orders to the field.

While the 72nd Skye Armor moved in on the landing zones, Snord's Irregulars were ordered to punch a hole in the Kurita advance and, if possible, hit their rear supply units. With little outside support, Rhonda Snord deployed her forces in two small groups, broken down into lances.

Facing Rhonda was newly promoted *Tai-sa* Fengo Olesko, who had survived her first brush with Snord's Irregulars when they secured Vega during the initial F-C thrust. After her rescue from the Bandli Wastes, Fengo swore revenge on the Irregulars. She chose the Carrier Highlands to fulfill her vow.

*Tai-sa* Olesko personally led the Second Legion of Vega forces. Although she held a numerical superiority on the ground, she had not counted on the Irregulars' air lance joining the battle. Rhonda broke through the Kurita line with several of her 'Mechs, but took heavy damage in doing so. Three days later she was forced to withdraw for repairs.

The Second Legion of Vega went on to secure the planet once again as a Combine world. However, *Tai-sa* Olesko lost her chance at revenge, and was forced to accept the death of long-time Irregular Solomon Storm as the only evidence of her honorable victory.



# CAMPAIGN: OPERATION MERLIN

## SITUATION: CAMELOT COMMAND, 3 OCTOBER 3051

Intelligence reports gathered by Cranston Snord made a strong case for the existence of a Star League base hidden in the Dark Nebula. The reports failed to indicate coordinates for the location of this base, but these coordinates were thought still available from an undisturbed Star League Astronomical Survey Station on Apollo. Rhonda Snord undertook a raid on Apollo in hopes of recovering chips and star charts that would reveal the location of the base in the Dark Nebula. Coordinates for the base were found, but the Jade Falcons were able to follow the Irregulars to Camelot Command. The two forces battled for possession of the old Star League naval base, and the outcome changed the face of Snord's Irregulars for decades to come.

The following six scenarios describe Operation Merlin, the campaign for possession of Camelot Command.

## MISSION DEBRIEFING

—Transcript of Operation Merlin mission debriefing, Colonel Rhonda Snord and Field Marshall Nondi Steiner, 3 October 3051.

SNORD: Initial intelligence reports gathered primarily by my father and his aide determined there was a strong probability of a Star League base hidden in the Dark Nebula.

STEINER: What was the reason for your raid on Apollo?

SNORD: What we lacked was exact information on the base's location. Our research showed that at one time a small Star League Astronomical Survey Station was located there. Evidence also indicated that the station had never been discovered, and that no artifacts or documents from the base had ever surfaced. We felt there was a good chance that the outpost was still hidden on Apollo, and that the information we needed would be intact.

STEINER: Having looked over your battalion's reports of the operation, I see that you opted for a fast raid against the Jade Falcons on Apollo, despite the fact that this world was deep in Clan-controlled space.

SNORD: Yes. We determined that Apollo was not a primary world, and was likely to be occupied by second-line Clan troops.

STEINER: Your landing and subsequent battles with the Jade Falcons were unorthodox at best. You assumed a great risk in choosing a combat trial for the remains of the base.

SNORD: Clan Warriors are skilled, but do not adapt well to our fighting style and tactics. As outlined in my reports, my father and I had intimate knowledge of the Clans and their methodologies prior to our engagements with the Dark Wing Cluster. We used that knowledge to our advantage, and beat them at their own game.

STEINER: Still, Colonel Snord, you only complicated matters by proceeding on to "Camelot Command" rather than returning to the Federated Commonwealth for reinforcements.

SNORD: I agree that this was a severe risk, but I also felt that the Clans stood a good chance of discovering our destination. I know these warriors and how they think. To them, a Star League naval base would be like a cathedral, a holy site. If they reached it first, we would stand no chance of wresting it out of their hands. By getting there first, we forced them to play our game.

STEINER: I admire your thinking, Colonel, and your intimate knowledge of the Clan mentality seems to have paid off in this case. I was most impressed with your defense of Camelot.

SNORD: The Falcons—for that matter, all the Clans—fight for the short term. I decided to slowly and methodically wear them down. In each battle I maneuvered them into making costly mistakes, and each time whittled down their forces a little more in the process. It was a close race, but in the end we came out ahead.

STEINER: I commend you on your tactics, Colonel. Your strategies stretch the definition of traditional thinking and style, but you seem to have used them effectively against these Jade Falcons. You've bought us a new base, and have given a boost to the F-C's morale. Good job.

SNORD: Thank you, Field Marshal. In the words of the classic musician Joel, "It's still rock and roll to me!"

## CAMPAIGN RULES

As with all previous scenarios, players should use the **BattleTech Compendium** rules. Any other optional or specific rules are given in each scenario.

The one exception is **Men-At-Arms: Scenario 5**. This is a **BattleTroops** scenario and uses those rules.

## CLAN TACTICS

The Jade Falcon Clan believes in honorable, one-on-one combat, a precept of war respected by all the Clans. Thus, Clan forces are prohibited from attacking the Irregulars with anything more than one OmniMech per turn.

Clan MechWarriors also shun close combat, preferring to engage their targets with ranged weapons. Clan BattleMechs may not initiate physical attacks. However, Clan BattleMechs that are physically attacked may respond against their attacker, but only with a punch, kick, push, or club.

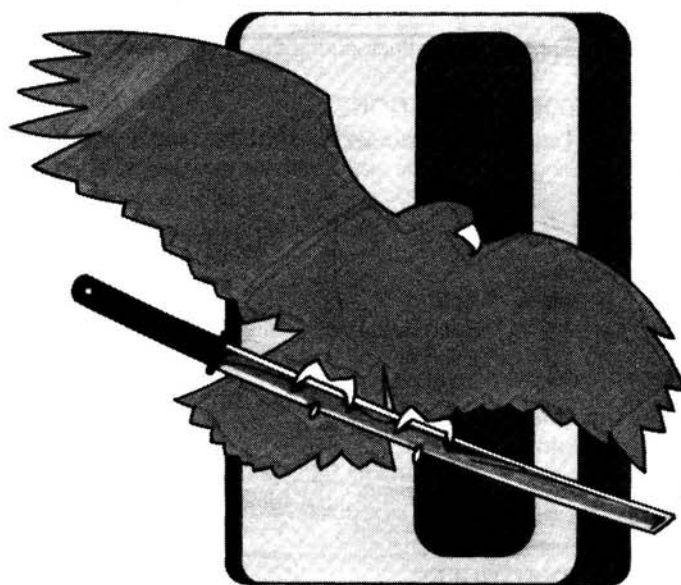

## HOSTILE ENVIRONMENTS

Use the optional **Hostile Environments** rules in the **BattleTech Compendium** (pp. 57–9) whenever appropriate. In particular, **Camelot's Gate: Scenario 3** essentially takes place in a vacuum, at one-tenth normal gravity.

All infantry and Elementals have the necessary equipment to function normally in a vacuum.

## INDOOR COMBAT

In Scenarios 4 and 6, the Irregulars square off against the Dark Wing Cluster inside rooms at least four levels tall. These rooms are large enough to accommodate vehicle and BattleMech fighting. The following rules apply to indoor combat.

### Terrain

Treat all clear terrain as pavement. No Death From Above attacks are allowed because the ceiling is too low.

### Walls and Doors

Walls are shown on the map as dark lines. Doors are indicated by flat rectangles. Units may not pass through walls or doors that have not been breached by combat fire or damage.

When a wall (or door) splits a hex, any unit in that hex is on the side of the wall containing the majority of the hex.

### Breaches

Walls and doors can be breached by damage. When a door hex takes 35 or more points of damage, or when a wall hex takes 50 or more points of damage, put a rubble counter on the door or wall. At this point, an infantry unit can pass through the breach. However, continue to keep track of how much total damage the door or wall has taken (most easily by noting it on the back of the counter), because additional damage is required for a vehicle or BattleMech to pass through the breach. (This is an exception to the standard **BattleTech** breach rules.) The Breaches Table indicates how much damage a breach must take before each type of unit may pass through it.

BREACHES	
Damage Needed	Action
35	Breach door for infantry or Elemental entry
50	Breach wall for infantry or Elemental entry
55	Breach door for tracked vehicle entry
65	Breach door for BattleMech entry
75	Breach wall for tracked vehicle entry
100	Breach wall for BattleMech entry

It costs 2 MP to cross a hex with rubble. Wheeled vehicles cannot enter rubble. A BattleMech or vehicle entering a rubble hex must make a *Piloting* Skill Roll.

### Debris

The warehouses of Camelot Command have several areas mounded with piles of old crates and other debris. As with other terrain, these hexes block line-of-sight and targeting, and cannot be entered by vehicles or BattleMechs. Each debris contour line is 1 level high.

### Pillars

Pillars are scattered throughout the warehouse bays, as marked on the map. An infantry or Elemental unit may elect to have any LOS from *one* enemy unit blocked by "hiding" behind a pillar in the hex it occupies as long as it does not attack. Otherwise, pillars do not block line-of-sight.

Each pillar has CF 15. If a pillar takes 15 or more points of damage it collapses, along with some of the ceiling structure in the area. If a pillar collapses, any unit in the pillar's hex or in a hex adjacent to the pillar must roll 2D6. A result of 7 or higher indicates that the unit was hit. The falling pillar and debris does 4D6 points of damage to each unit it hits. For BattleMech damage locations use the Strafing Damage to BattleMechs Table in the **BattleTech Compendium** (p. 97). For vehicle damage locations, use the appropriate vehicle hit location tables in the **BattleTech Compendium**, pp. 41-3.

### Guardian ECMs

A Guardian ECM's range is reduced by two hexes when used through an unbreached wall or door.

## NORMAL PLAY

For normal play, use the Irregulars' and Dark Wing Cluster's listings, as provided with each scenario. Using this method, each scenario stands on its own and the results of one do not affect the others.

## CAMPAIGN PLAY

For campaign play, the Irregulars player begins with the full battalion of Snord's Irregulars and the Jade Falcons player begins with the Dark Wing Cluster (see roster below).

In each scenario the player uses the lances listed under **Defender** and **Attacker**, but their condition carries over from previous scenarios and to subsequent scenarios. In other words, if a Mech loses its medium pulse laser in the first scenario, the laser is not available in subsequent scenarios until it has been repaired.

Use the optional **Prizes, Repairs, and Scavenging** rules in the **BattleTech Compendium** (pp. 61–2) to attempt repairs.

The time between scenarios in the campaign is as follows:

Scenario	Repair Time
1 to 2	1 hour
2 to 3	equipment fully repaired (see below)
3 to 4	1 hour (only the Irregulars may conduct repairs during this period)
4 to 5	NA ( <b>BattleTroops</b> scenario)
4 to 6	30 minutes

Three weeks pass between the second and third scenarios. During this time both sides may repair all the damage incurred during the Apollo raid. Since the Irregulars stocked ample supplies of armor, myomer, and other repair parts for the voyage, most of the repairs can be completed. By the time they arrive at Camelot Command, both the Irregulars and the Jade Falcons are at full strength.

If the Irregulars win the first scenario, they may fight using any of the Clan OmniMechs they won in the combat trial. However, they have no repair parts or extra ammunition for their new OmniMechs, and all *Piloting* and *Gunnery* Skill Rolls are at +1 because the equipment is unfamiliar.

### Elemental Infantry (Scenario 5)

If the players are conducting a campaign, then only the Elementals that exited Scenario 4 through the door in Hex 0416 may be used as the Clan Elementals for this scenario.

For each hit that an Elemental has taken before Scenario 5, mark off an armor box on the **BattleTroops** damage sheet for Scenario 5.

# JADE FALCONS ROSTER

The unit that Snord's Irregulars faces throughout Operation Merlin is the Dark Wing Cluster of the Jade Falcons. The Dark Wing Cluster is part of the Gamma Galaxy and is one of five Falcon clusters composed entirely of warriors who have, either from old age (by Clan standards) or injury, tested out of more prestigious positions in the Falcons. They live to die an honorable death in combat, but are usually assigned to rear areas as garrison forces. The engagements with Snord's Irregulars present a rare opportunity for them to test their skills and achieve an honorable death. This attitude makes them one of the most potent fighting units in the Falcons, despite their apparently low stature within the Warrior Caste.

## UNIT ROSTER, DARK WING CLUSTER, JADE FALCONS CLAN

**Name:** The Dark Wing Cluster (The Dark Wings, The Dark Wings of Death)

**Commander:** Star Colonel Damon

**Unit Composition:** Six BattleMech Stars, 2 Elemental Stars (1 star assigned with BattleMechs)

**Unit Status:** Veteran/Elite

**Unit Insignia:** A dark green falcon holding a BattleMech's arm in its talons

**Unit Nickname:** The Old Vultures

**Unit Assignments:** JumpShip *Hawk-Eye* (Aegis Class), Drop-Ships *Diamondstar* and *Majestic Defiance* (Both Clan Union Class)

### DARK WING CLUSTER COMMAND STAR

Star Colonel Damon (*Piloting 2, Gunnery 1*), *Thor*  
Star Commander Veltix (*Piloting 1, Gunnery 3*), *Thor B*  
MechWarrior Trisha (*Piloting 2, Gunnery 2*), *Uller C*  
MechWarrior Unis (*Piloting 2, Gunnery 3*), *Uller*  
MechWarrior Bhamenn (*Piloting 3, Gunnery 4*), *Uller B*

### TRINARY ALPHA

#### Alpha Heavy

Star Captain Trojon (*Piloting 3, Gunnery 1*), *Vulture*  
MechWarrior Darakon (*Piloting 2, Gunnery 1*), *Vulture B*  
MechWarrior Deborah (*Piloting 3, Gunnery 4*), *Vulture*  
MechWarrior Addison (*Piloting 3, Gunnery 4*), *Koshi D*  
MechWarrior Vargus (*Piloting 3, Gunnery 3*), *Koshi*

#### Alpha Shield

Star Commander Yolls (*Piloting 1, Gunnery 2*), *Ryoken B*  
MechWarrior Adrian (*Piloting 3, Gunnery 3*), *Ryoken A*  
MechWarrior Savrus (*Piloting 3, Gunnery 4*), *Mad Cat D*  
MechWarrior Shultz (*Piloting 1, Gunnery 3*), *Mad Cat*  
MechWarrior Terry (*Piloting 2, Gunnery 3*), *Ryoken C*

#### Alpha Probe

Star Commander Harris (*Piloting 1, Gunnery 2*), *Dasher B*  
MechWarrior Tokko (*Piloting 2, Gunnery 4*), *Dasher A*  
MechWarrior Robin (*Piloting 1, Gunnery 3*), *Dasher*  
MechWarrior Gallis (*Piloting 1, Gunnery 2*), *Dasher D*  
MechWarrior Stringfellow (*Piloting 2, Gunnery 4*), *Dasher*

### TRINARY BRAVO

#### Bravo Supernova

Star Captain Norris (*Piloting 1, Gunnery 1*), *Black Hawk*  
Point Commander Hannis, 4 Elementals  
MechWarrior Nanette (*Piloting 2, Gunnery 2*), *Thor B*  
Point Commander Sherry, 4 Elementals  
MechWarrior Drast (*Piloting 1, Gunnery 4*), *Puma C*  
Point Commander Franklin, 4 Elementals  
MechWarrior Carter (*Piloting 2, Gunnery 3*), *Puma B*  
Point Commander Miki, 4 Elementals  
MechWarrior Von-Kapper (*Piloting 2, Gunnery 3*), *Uller*  
Point Commander Asaki, 4 Elementals

#### Bravo Sweep

Star Commander Ultor (*Piloting 1, Gunnery 2*), *Koshi B*  
MechWarrior Flange (*Piloting 1, Gunnery 2*), *Dasher A*  
MechWarrior Durg (*Piloting 3, Gunnery 4*), *Dasher C*  
MechWarrior Terrence (*Piloting 2, Gunnery 3*), *Uller*  
MechWarrior Brace (*Piloting 3, Gunnery 3*), *Dasher*

#### Bravo Hold

Elemental Star Commander Holly, 4 Elementals  
Point Commander Diane, 4 Elementals  
Point Commander Front, 4 Elementals  
Point Commander Debby, 4 Elementals  
Point Commander Derrick, 4 Elementals





# WARRIOR'S CHALLENGE: Scenario I

## TRIAL OF POSSESSION

"Colonel, we pulled back as soon as we made contact," Shorty signaled. "It looks like we're facing about a Star of medium OmniMechs, Clan Jade Falcons."

Rhonda knew the Clans and their ways. How she handled the communications with the Falcons was going to be important. The Irregulars had to be careful or their mission to Apollo would be over in a matter of minutes.

She signaled the entire battalion on the command channel.

"Irregulars, we've detected a Clan unit. Follow orders to the letter or we can all end up dead. Stand by for my word." She scanned the frequencies until she found the Jade Falcons.

Rhonda moved her *Highlander* to the edge of the dry woods and sent out a locator signal. In three minutes a Star of Jade Falcons appeared. Rhonda tuned in their command frequency and began to speak.

And Nicholas bade them that battles could be waged for property and goods,

And that innocents need not perish.

Thus he instructed the Khans as to the Trial of Possession, Its rules specific and just...

There was a long pause. The lead Jade Falcon *Vulture* replied. "Who quotes to us from the Remembrance? Such works are not known to the Inner Sphere and to mock them is unadvised."

Rhonda stated the traditional challenge. "I am Colonel Rhonda Snord of Snord's Irregulars of the Federated Commonwealth. I demand the rite of Trial of Possession for the building to the south as well as the contents therein. What forces defend that structure?"

"I am Star Captain Trojon of the Dark Wings of Clan Jade Falcon. The Warriors of Tertiary Alpha, Alpha Heavy defend that building and its contents in the name of our Clan and our Khan."

One Star. Rhonda switched back to her own command channel. "Irregulars, listen up. Under no circumstances interfere with this battle. Shorty, Walker, Bright, and Charlotte report to me for a duel against the Falcons."

Rhonda grinned. She had an edge. Now she had to beat these Falcons.

## GAME SET-UP

Lay out the maps as shown. Before beginning play, place a rubble counter on Hex 9013 of the south map. This represents the remains of the Star League outpost.

Treat all water/stream hexes on the map boards as clear terrain.

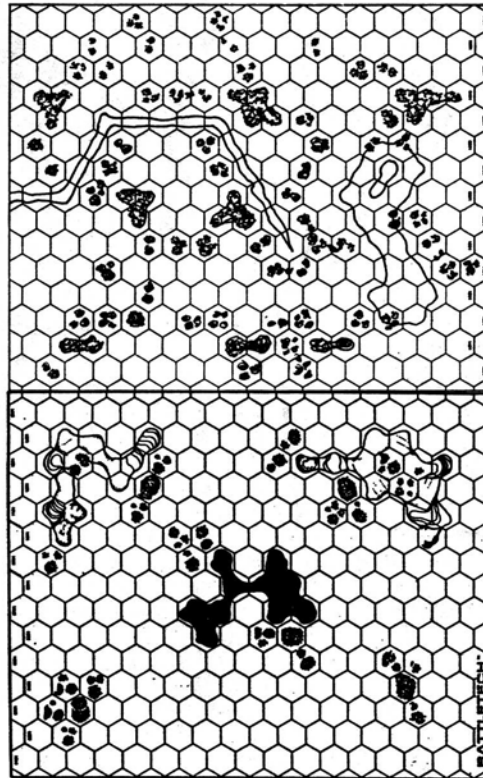

## DEFENDER

The Defender is the Alpha Heavy Star, Tertiary Alpha, Dark Wing Cluster, Jade Falcons. All the Falcon OmniMechs are in good condition.

### Alpha Heavy

Star Captain Trojon (*Piloting 3, Gunnery 1*), *Vulture*  
MechWarrior Darakon (*Piloting 2, Gunnery 1*), *Vulture B*  
MechWarrior Deborah (*Piloting 3, Gunnery 4*), *Vulture*  
MechWarrior Addison (*Piloting 3, Gunnery 4*), *Koshi D*  
MechWarrior Vargus (*Piloting 3, Gunnery 3*), *Koshi*

### Deployment

The Defender may set up anywhere at least eight hexes from the south edge of the north map.

**ATTACKER**

The Attacker consists of an informally formed combat "Star" of Snord's Irregulars. All the Irregulars' 'Mechs are in good condition.

**First Irregulars Informal Star**

Colonel Rhonda Snord (*Piloting 2, Gunnery 1, Highlander*)  
 Charlotte Deblois (*Piloting 3, Gunnery 1, Thug*)  
 Walker Roche (*Piloting 3, Gunnery 2, Champion*)  
 Captain Samuel "Shorty" Sneede (*Piloting 1, Gunnery 1, Crockett*)  
 Lieutenant Bright Thomlinson (*Piloting 2, Gunnery 1, Crockett*)

**Deployment**

The Attacker may set up on any clear terrain hexes within three hexes of the border between the north and south maps.

**VICTORY CONDITIONS**

The Attacker (the Irregulars player) is awarded points based on the condition of the Defender after 10 turns of play. A positive number indicates an Attacker victory, while a negative number indicates a Defender victory.

**VICTORY TABLE**

Points	Condition
1	Each Irregulars 'Mech able to move or fire after Turn 10
2	Each Jade Falcons OmniMech unable to move or fire after Turn 10
-2	Each Irregulars 'Mech unable to move or fire after Turn 10
-1	Each Jade Falcons OmniMech able to move or fire after Turn 10

**SPECIAL RULES**

Use the optional **Fire** rules from the **BattleTech Compendium** (p. 53-4). These rules are modified as follows:

All non-water hexes are flammable (including clear terrain hexes).

Wooded hexes generate more heat than usual, because of the dry underbrush. Add 2 points of heat accumulation to both the "Moving Out" and the "Standing In" totals (4 and 7, respectively).

Use standard heat accumulation values for non-wooded hexes that are on fire.

Clan OmniMechs may not intentionally start fires.

The prevailing wind is to the north.

Subtract 3 from all Target Numbers for starting fires on the Starting Fires Table to reflect the dry nature of the Tinkler Forest.

Subtract 2 from all Target Numbers for spreading fires on the Starting Fires Table.

The goal of the Irregulars' raid was to locate and secure the Star League astronomical research station believed to be on Apollo. Because of the isolated region being searched, the only indication of Clan Jade Falcons' presence was their persistent fighter flybys. From what Rhonda was able to determine, they simply did not have any forces in the region to intercept and deal with the Irregulars' intrusion.

After three days of searching the Tinkler Forest, the Irregulars discovered the remains of the long-abandoned outpost. She dispersed BattleMechs to provide a defensive perimeter while technicians and infantry removed the vital maps and computer storage chips. These were carefully crated for transport.

On 14 August, the Jade Falcon's Trinary Alpha Heavy Star discovered the Irregulars in the dense woods. Rhonda used her Clan knowledge to challenge the Falcons to a combat Trial of Possession for the outpost and its contents.

The Dark Wing Cluster was composed of older warriors or those who had simply tested out of more prestigious positions. The arrival of the Irregulars provided them with an opportunity to prove themselves worthy to be Jade Falcon warriors.

In the tradition of the Clans, Rhonda chose five of the Irregulars to form a Star equivalent to that of the Falcons. She specifically selected Walker Roche and Shorty Sneede for their intimate knowledge of the Clans and combat trials.

Under normal conditions the match would have been even, but Rhonda's research indicated that the Tinkler Forest was suffering from a two-month drought, making it highly combustible. She immediately fired the brush around the Falcon OmniMechs.

The prevailing wind met the bone-dry brush and burst into a roaring forest fire. The inferno was centered on Falcon OmniMechs. Under normal conditions they should have been able to vent more than enough heat to deal with the Irregulars, but the raging fire caused two of them to overheat, and Rhonda and the Irregulars' Star took out the remaining Falcons.

The Falcons not killed during the brief battle surrendered, claiming the right of bondsmanship to "Clan Snord." Rhonda quickly accepted their offer and set her technicians to work on the OmniMechs in order to get them functional. The Jade Falcons knew where they were, and she needed to get the Irregulars off Apollo.

# GRAND MELEE: Scenario 2

## IF YOU CAN'T STAND THE HEAT

—From a transcript of the debriefing interview, Federated Commonwealth High Command and Captain Deb H'Chu, Third Company CO, Snord's Irregulars. Tape 3009-889J.

H'CHU: I must admit, even I was shocked. After a few minutes of fighting, the Clan OmniMechs that could still fight just surrendered. Their warriors came out saying something about bondage and Clan Snord. I thought that the heat must've gotten to them.

FCHC: What happened then, Captain?

H'CHU: We patched together two of those awful machines and got them running. The Colonel had us divide up the maps and data chips just in case something went wrong. Sure enough, it did, about an hour later.

FCHC: And that was when the Falcons attacked again?

H'CHU: Not exactly. My Fire Lance and Rhonda's Recon were combing the southwest arm of the forest when they stumbled on another Star of OmniMechs. One of our newer men, Darkside Burns, opened fire before Rhonda could get there. Well, the next thing we knew, we had Clanners hitting us from all over the place.

Rhonda had to divert the DropShips twice, and still couldn't find an LZ the pilots could live with. So we opted for the next best thing and cleared off some of the light forest so that the ships could land and pick us up. Shorty's Support Lance of armor and my Fire Lance were the slowest forces, and so we had to fight a rear-guard action just to get out of the woods.

FCHC: You obviously made it out, though.

H'CHU: Yes sir, that we did. We lost a crate of those old chips in the process, however, along with three of our tanks. Two of our 'Mechs got wadded up like old tin cans. They still functioned, but just barely. The Jade Falcons withdrew as soon as they spotted our DropShips on final approach.

FCHC: But those lost chips didn't matter too much, did they? You must still have had the maps to Camelot Command on the recovered chips.

H'CHU: Sure we did. We found out just how valuable that lost crate was, though, when the Jade Falcons paid us a visit just a short time later.

## GAME SET-UP

Lay out the maps as shown.

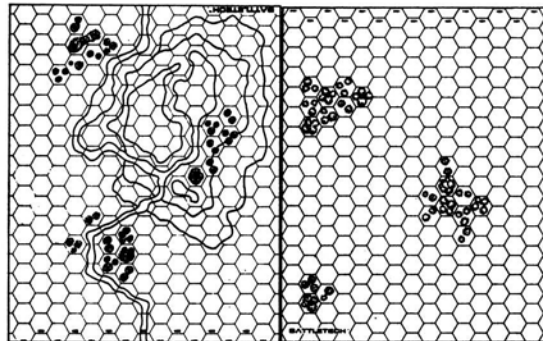

### DEFENDER

The Defender consists of Snord's Irregulars Second Company Support Lance and Third Company Fire Lance.

#### Support Lance

Lieutenant Darrell Lanst (*Piloting 3, Gunnery 3*), Padilla Artillery Tank  
Dorchester Quinn (*Piloting 4, Gunnery 2*), Burke Heavy Tank  
Archie Ferris (*Piloting 4, Gunnery 1*), Demon Armored Car  
Nathan "Beaver" Hauck (*Piloting 2, Gunnery 3*), Rotunda Scout Car

#### Fire Lance

Lieutenant Bright Thomlinson (*Piloting 2, Gunnery 1*), *Crockett*  
Linda Thomlinson (*Piloting 4, Gunnery 1*), *Flashman*  
Blade Windall (*Piloting 1, Gunnery 2*), *Highlander*  
Dalid "Darkside" Burns (*Piloting 5, Gunnery 3*), *Enforcer*

#### Deployment

The Support Lance may set up anywhere on the west map within 12 hexes of the west edge. The Fire Lance may set up anywhere on the east map.

### ATTACKER

The Attacker consists of elements of the Dark Wing Cluster, Tertiary Alpha, Alpha Shield, and Alpha Probe Stars.

#### Alpha Shield

Star Commander Yolls (*Piloting 1, Gunnery 2*), *Ryoken B*  
MechWarrior Adrian (*Piloting 3, Gunnery 3*), *Ryoken A*  
MechWarrior Savrus (*Piloting 3, Gunnery 4*), *Mad Cat D*  
MechWarrior Shultz (*Piloting 1, Gunnery 3*), *Mad Cat*  
MechWarrior Terry (*Piloting 2, Gunnery 3*), *Ryoken C*

#### Alpha Probe (Partial Star)

Star Commander Harris (*Piloting 1, Gunnery 2*), *Dasher B*  
MechWarrior Tokko (*Piloting 2, Gunnery 4*), *Dasher A*  
MechWarrior Robin (*Piloting 1, Gunnery 3*), *Dasher*

#### Deployment

The Attacker begins Turn 1 by entering on the west map's west edge.

### VICTORY CONDITIONS

The scenario lasts 15 turns, after which each side is awarded points for certain conditions. The side with the most points wins the scenario.

### VICTORY TABLE

#### Attacker (Jade Falcons)

Points	Condition
1	Each Irregulars tank unable to move or fire
2	Each Irregulars 'Mech unable to move or fire
2	Each Irregulars unit on the map at end of scenario
5	Each Irregulars 'Mech destroyed while carrying a crate

#### Defender (Snord's Irregulars)

Points	Condition
2	Each Jade Falcon OmniMech unable to move or fire
2	Each Irregulars unit exited off the east edge of the east map
1	Each Irregulars unit exited off the south edge of the east map

### SPECIAL RULES

Use the optional **Fire** rules in the **BattleTech Compendium** (pp. 53-4).

The Defender must choose two of the Irregulars' Fire Lance 'Mechs (Defender's choice) to carry crates filled with maps and data chips. If either 'Mech is destroyed, the Attacker earns victory points.

With much of the northwest Tinkler Forest in flames, Rhonda Snord attempted to pull her battalion out of the forest. She ran into difficulties, the worst of which was the arrival of more Jade Falcons.

One of the younger MechWarriors, Dalid Burns, panicked and opened fire on a *Dasher* OmniMech, which prevented Rhonda from once again challenging the Falcons. The Clan OmniMechs mounted a swift attack, but the Irregulars were able to even the odds by successfully massing their firepower.

With no hope of reaching either her initial LZ or the backup location, Rhonda decided to make her own. She led most of the Irregulars ahead of the ground armor and began to clear off light woods so that the DropShips could land. Meanwhile, the Clan OmniMechs caught up with the ground armor and the Third Company's Fire Lance, who were still trying to make their way to the newly burned-off LZ.

The Dark Wing's Trinary Alpha, Alpha Shield Star, pounced on the armor, only to be shocked by what they encountered. Their reports of Inner Sphere ground armor indicated it was vastly inferior to 'Mechs. In the case of Snord's Irregulars, with its Star League equipment, the Dark Wing Cluster found itself facing a counterattack of heavy fire.

The bold action of the Third Company's Fire Lance saved the embattled Support Lance. Led by Lieutenant Bright Thomlinson, the Fire Lance cut off Dark Wing Cluster support forces long enough for the armor to make a break for the landing DropShips. However, one of the crates of computer chips was lost in the fight, and it contained information on the Irregulars' next destination. This information made possible a Jade Falcons attack at Camelot Command.

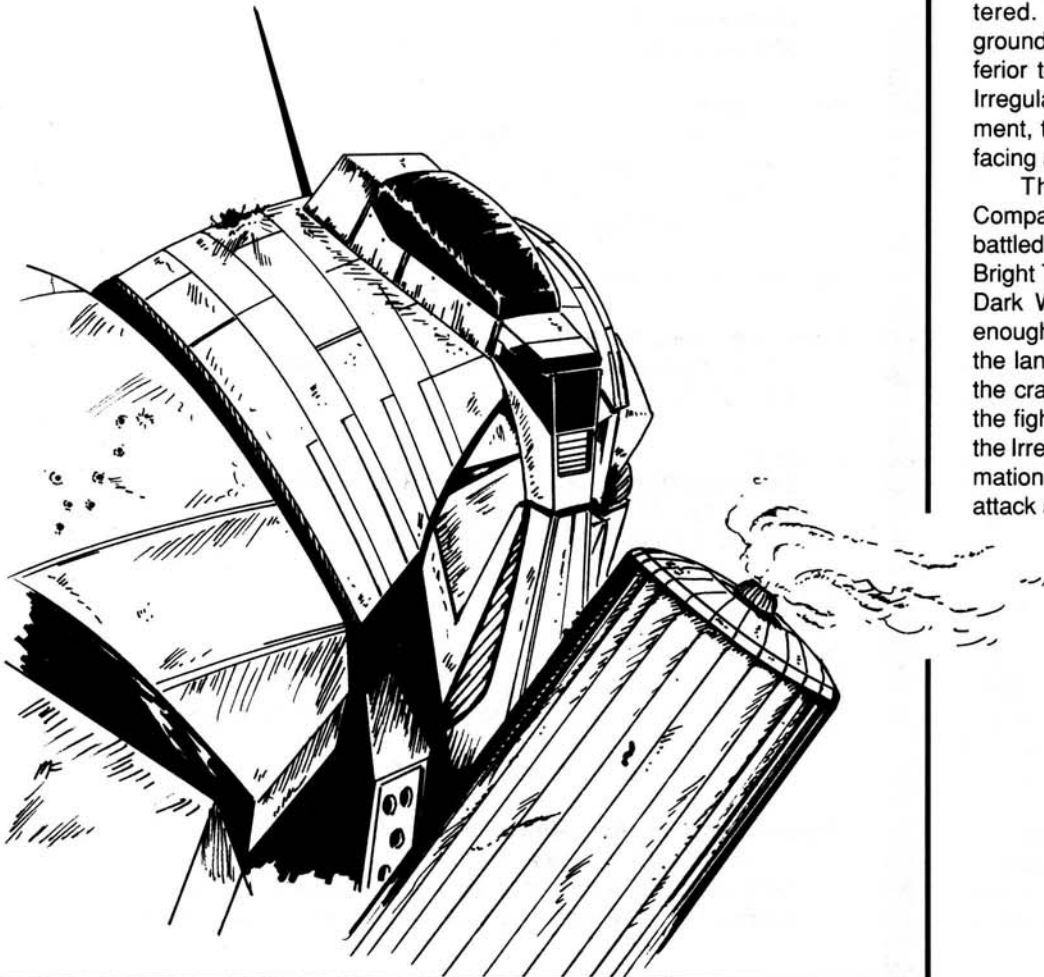



# CAMELOT'S GATE: Scenario 3

## EVENING THE ODDS

—From the private log of Star Captain Norris, Clan Snord, October 3051

These mercenaries who call themselves Snord's Irregulars are most unusual. Their leader knew our traditions and ways, and even spoke to us from the Remembrance. Their equipment was from the Star League, in almost perfect condition. They did not fit any of our reports of known units in the Inner Sphere, and so Star Colonel Damon was intrigued.

We acknowledged and honored their right to the ruins in Tinkler Forest, but discovered a large bundle of computer chips left behind in their retreat. Our scientists' examination revealed that the chips contained astronomical maps, which led the Star Colonel to guess that the real reason for the raid on Apollo was to gain coordinates for a Star League naval base hidden in the Dark Nebula.

Our Khan granted us the opportunity to earn the right to an honorable death by following the Irregulars to this hidden base, and to win it in the name of Clan Jade Falcons.

We received a shock at the end of our journey. We had arrived at a planetoid clearly marked as one of the SLDF bases. Rapid spinning provided gravity in the planetoid's interior, but not on the surface.

The colonel issued his challenge first: "I am Star Colonel Damon of the Dark Wing Cluster of the Jade Falcons. What forces defend this base?"

Colonel Snord responded in perfect traditional form. "I am Colonel Rhonda Snord, daughter of the freebirth warrior Cranston, and I and my battalion defend this station against all who would take it. I place twenty-four BattleMechs, four tanks, three fighters, and four platoons of infantry in defense of Camelot Command. I also demand the right of total possession, that if we win we own your men, machines, and DropShips as our own."

"Well-offered and challenged, Colonel Snord. On behalf of my warriors, I accept your bid. May you fight valiantly to the quick and painless end due a warrior of such stature and skill."

"Well-bargained and accepted, Star Colonel Damon. May your defeat today be so honorable and great that you and your men are given a line in the Remembrance."

Thus the battle began.

## GAME SET-UP

Lay out the maps as shown.

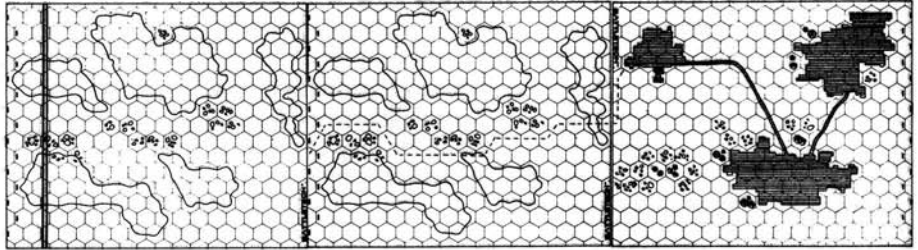

## DEFENDER

The Defender consists of elements of Snord's Irregulars. Despite action on Apollo earlier in the month, all Irregulars equipment is in good condition.

### First (Command) Company, Rhonda Snord's Irregulars

#### Command Lance

Colonel Rhonda Snord (*Piloting 2, Gunnery 1*), *Highlander*  
Dennis Maltesta (*Piloting 2, Gunnery 2*), *Excalibur*  
David Rowsch (*Piloting 3, Gunnery 2*), *Guillotine*  
Sharonus Wayne (*Piloting 3, Gunnery 2*), *Spartan*

#### Attack Lance

Lieutenant Marcos Shake (*Piloting 2, Gunnery 1*), *Bombardier*  
Tempest Storm (*Piloting 3, Gunnery 2*), *Spartan*  
Anthony Pryor (*Piloting 3, Gunnery 1*), *Lancelot*  
Charlotte Deblois (*Piloting 3, Gunnery 1*), *Thug*

### Second Company (Shorty's Scavengers)

#### Command Lance (Partial)

Daniel Trump (*Piloting 2, Gunnery 2*), *Champion*  
Marleen Danules (*Piloting 4, Gunnery 2*), *Crab*

#### Air Lance

Lieutenant Richter Nikmen (*Piloting 3, Gunnery 2*), *Rapier*  
Travis Horr (*Piloting 3, Gunnery 3*), *Ironsides*  
Yolinda Brekner (*Piloting 4, Gunnery 2*), *Gotha*

### Third Company

#### Command Lance

Captain Deb H'Chu (*Piloting 1, Gunnery 1*), *Exterminator*  
Lieutenant Terry Malvinson (*Piloting 2, Gunnery 1*), *Lancelot*  
Victoria Rose (*Piloting 3, Gunnery 2*), *Excalibur*  
Richard "Rickbo" Burkeman (*Piloting 3, Gunnery 1*), *Champion*

#### Support Platoons (Anti-Mech Trained)

Lieutenant Fasha Nagaraj, *Elite*  
Sergeant Baca Tsaprazis, *Veteran, Jump Infantry (Laser)*  
Sergeant Nanette Warkentin, *Regular, Motorized Infantry (SRM)*

**Gun Emplacements**

Tonnage:	100 tons
Number of Hexes:	1
Internal Structure:	10
Armor:	400 points, 25 tons
200 Points to outer walls	
200 Points to turret	
Power Plant:	Hermes 100, 6 tons
Heat Sinks:	14, 14 tons
Weapons:	
1 ER PPC	7 tons
1 Anti-Missile System	.5, 3 tons
Ammo/Anti-Missile (36)	3, 1 ton
Gauss rifle	5, 8 tons
Ammo/Gauss rifle (64)	8

Note: Gauss rifle and ER PPC are mounted in turret. All other ammo and equipment are mounted in main housing of the installation.

**Deployment**

The Defender must set up all ground units before beginning play on the center and west map, at least 6 hexes from the west edge of the east map.

The Defender's Air Lance may enter the west edge of the west map beginning on Turn 4.

The Defender receives two gun emplacements as described above, on the east map at Hexes 0403 and 1111. These installations are remotely controlled from within the base by two gunners, each with *Gunnery Skill 4*.

**ATTACKER**

The Attacker's initial wave consists of the Dark Wing Command Star, Trinary Alpha's Probe and Shield Stars, and Trinary Bravo's Sweep Star. Trinary Bravo's Supernova Star reinforces on Turn 3.

**Dark Wing Command**

- Star Colonel Damon (*Piloting 2, Gunnery 1*), *Thor*
- Star Commander Veltix (*Piloting 1, Gunnery 3*), *Thor B*
- MechWarrior Trisha (*Piloting 2, Gunnery 2*), *Uller C*
- MechWarrior Unis (*Piloting 2, Gunnery 3*), *Uller*
- MechWarrior Bhamenn (*Piloting 3, Gunnery 4*), *Uller B*

**Trinary Alpha**

**Alpha Probe**

- Star Commander Harris (*Piloting 1, Gunnery 2*), *Dasher B*
- MechWarrior Tokko (*Piloting 2, Gunnery 4*), *Dasher A*
- MechWarrior Robin (*Piloting 1, Gunnery 3*), *Dasher*
- MechWarrior Gallis (*Piloting 1, Gunnery 2*), *Dasher D*
- MechWarrior Stringfellow (*Piloting 2, Gunnery 4*), *Dasher*

**Alpha Shield**

- Star Commander Yolls (*Piloting 1, Gunnery 2*), *Ryoken B*
- MechWarrior Adrian (*Piloting 3, Gunnery 3*), *Ryoken A*
- MechWarrior Savrus (*Piloting 3, Gunnery 4*), *Mad Cat D*
- MechWarrior Shultz (*Piloting 1, Gunnery 3*), *Mad Cat*
- MechWarrior Terry (*Piloting 2, Gunnery 3*), *Ryoken C*

Continued on pages 60-61

The outer surface of Camelot Command was a desolate wasteland. Only a pitted AeroSpace landing strip and several DropShip landing pads broke up the flat terrain. Colonel Snord was concentrating her forces on defense of the landing pads, because this was the Jade Falcons' only choice for approaching the station.

Rhonda hoped to give the Dark Wing Cluster their first damage here. The surface vacuum meant that a penetrating hit could cause a limb to rupture and explode from rapid decompression. As Colonel Snord put it, "despite their advances in technology, the Jade Falcons take a hit and damage out here just like the rest of us."

The speed of the Jade Falcons' OmniMechs made them dangerous, but the light surface gravity gave the Irregulars the same degree of mobility as their opposition. On the surface of Camelot Command, the odds between the two sides were evened.

Rhonda had other tricks up her sleeve as well. Two of the old SLDF turrets had been made operational, which provided the Irregulars with fire support the Falcons couldn't anticipate. Also, the airlocks leading to the underground portions of the station were protected by an anti-BattleMech trench, dug centuries earlier. It could only be crossed at one narrow point, which would force the Jade Falcons to move and respond in ways the Irregulars could predict.

# CAMELOT'S GATE

## CAMELOT'S GATE rules continued

### Trinary Bravo

#### Bravo Sweep

Star Commander Ultor (*Piloting 1, Gunnery 2*), *Koshi B*  
MechWarrior Flange (*Piloting 1, Gunnery 2*), *Dasher A*  
MechWarrior Durg (*Piloting 3, Gunnery 4*), *Dasher C*  
MechWarrior Terrence (*Piloting 2, Gunnery 3*), *Uller*  
MechWarrior Brace (*Piloting 3, Gunnery 3*), *Dasher*

### Trinary Bravo

#### Bravo Supernova

Star Captain Norris (*Piloting 1, Gunnery 1*), *Black Hawk*  
Point Commander Hannis, 4 Elementals  
MechWarrior Nanette (*Piloting 2, Gunnery 2*), *Thor B*  
Point Commander Sherry, 4 Elementals  
MechWarrior Drast (*Piloting 1, Gunnery 4*), *Puma C*  
Point Commander Franklin, 4 Elementals  
MechWarrior Carter (*Piloting 2, Gunnery 3*), *Puma B*  
Point Commander Miki, 4 Elementals  
MechWarrior Von-Kapper (*Piloting 2, Gunnery 3*), *Uller*  
Point Commander Asaki, 4 Elementals

#### Deployment

The Attacker's initial forces set up on any pavement hex within ten hexes of the east edge of the east map.

Trinary Bravo's Supernova Star may enter the map along any edge within ten hexes of the east edge of the east map, beginning on Turn 3.

#### VICTORY CONDITIONS

The Attacker has two goals, to engage and destroy the Irregulars and to acquire terrain. The victory conditions reflect this.

The Defender wants to inflict as much damage as possible while withdrawing functional 'Mechs for later engagements with the enemy.

The Attacker (Jade Falcons Dark Wing Cluster) is awarded points for actions completed by the end of Turn 15. If these points are positive, the Attacker wins. If these points are negative, the Defender wins.

#### VICTORY TABLE

Points	Action
3	Each Defender's unit destroyed
2	Each Attacker's BattleMech exited off the west edge of the west map
1	Each Attacker's Elemental point exited off the west edge of the west map
1	Each installation destroyed
-2	Each Defender's unit (but not AeroSpace Fighters) exited off the west edge of the west map
-3	Each Attacker's unit destroyed or unable to move
-2	Each installation still functional
-2	Each Defender's AeroSpace Fighter still functional



## SPECIAL RULES

Use the optional **BattleTech Compendium** rules for **Strafing** (p. 96), **Anti-BattleMech Infantry** (pp. 47–8), **Gun Emplacements** (p. 57), and **Hostile Environments (Low Gravity and Vacuum)**, pp. 57–9). The gravity on the surface of Camelot Command is 10 percent of normal.

### Wooded Hexes

Treat all wooded hexes as clear terrain.

### Anti-BattleMech Trench

The Anti-BattleMech Trench is indicated on the west map. Any other terrain in the trench hexes is ignored. The trench is 3 levels deep and 1 hex across. Only BattleMechs capable of jumping may cross the trench. Any BattleMech walking or running into a trench hex immediately falls 2 levels and takes damage according to the falling rules.

BattleMechs and infantry in the trench may fire within the trench.

Firing into or out of the trench follows normal line-of-sight rules.

### Gun Emplacements

A "Crew Killed" result against a turret means that the turret weapons can no longer fire.

### Road

All hexes of the road marked on the map are clear terrain (pavement) of the indicated height.

### Bridge

There is a 100 CF bridge over the anti-BattleMech Trench in Hex 0602. Use standard rules for bridge movement and combat (p. 18).

### Irregulars Exiting the Map Board

The Irregulars receive Victory Points for exiting units off the west edge of the west map. This movement is allowed at Turn 11.

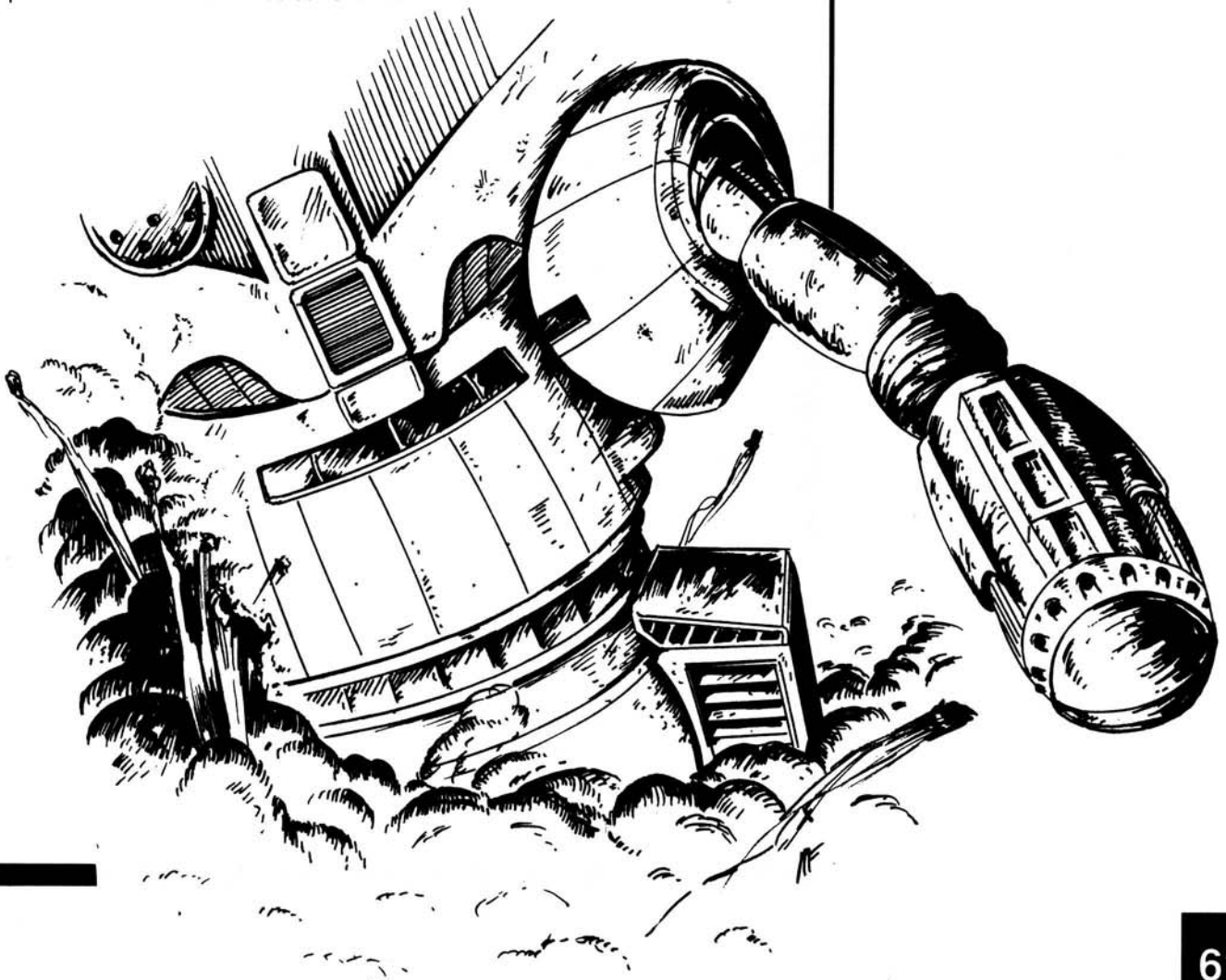



# PITCHED BATTLE: Scenario 4

## CORNERED RATS

—Transcript of the Operation Merlin debriefing with Charlotte Deblois, Attack Lance, Snord's Irregulars, 3 October 3051.

My *Thug* was doing all right—if you ignored the fact that my 'Mech's right arm exploded when I got hit, ripping off most of what I had there. Our Techs were able to get it shooting again, but I still had toilet paper for armor there. Not exactly the best feelin' I've had in a while.

These Clan-folk are powerful fighters, that much is for sure.

But the Colonel had a plan to defeat these guys and we stuck to it. She sealed the airlock from the inside. It was functional, but it was going to take them some time to get through it. They couldn't do repairs out in the vacuum, but we were high and dry, and managed to get a lot of our equipment and people up and running while the Falcons dug out the door.

We had dug in in what was at one time a bunch of *big* warehouses. They were huge, four stories tall with heavy walls all over the place. Thanks to the working airlocks, our tanks could operate in there.

We could tell when they made it into the airlock. It soon sounded like they were getting ready to blast through the door and probably punch through the wall as well.

We heard the fire as they started cuttin' through, and got ready. Quinn sat right next to the door, point-blank range. The first of the Clan-folk steppin' through caught three PPCs at once. When the smoke cleared, all we could see was a big pile of new spare parts. That didn't stop 'em, though. They broke through the wall further down, but Lieutenant Shake and the rest of us were waiting with a little surprise of our own.

The fighting was quick and furious, but we had set up a few surprises for the Clanners. One of them walked by a mountain of old parts and rotted crates only to get jumped at point-blank range by a platoon of our infantry. Before he knew what was happenin', our boys had nearly blown off his leg actuators.

Then it got messy real quick, with their infantry runnin' all over the place. Some called 'em Toads. Me, I called 'em rats—'cause they ran around in little packs, nibblin' at our heels.

Ain't nothin' harder to deal with than a cornered rat, let me tell you.

## GAME SET-UP

Lay out the maps as shown. Use the blank map sides of **BattleTech** map boards for the warehouse. Mark, or lay counters, paper strips, and so on to indicate walls, doors, debris, and pillars.

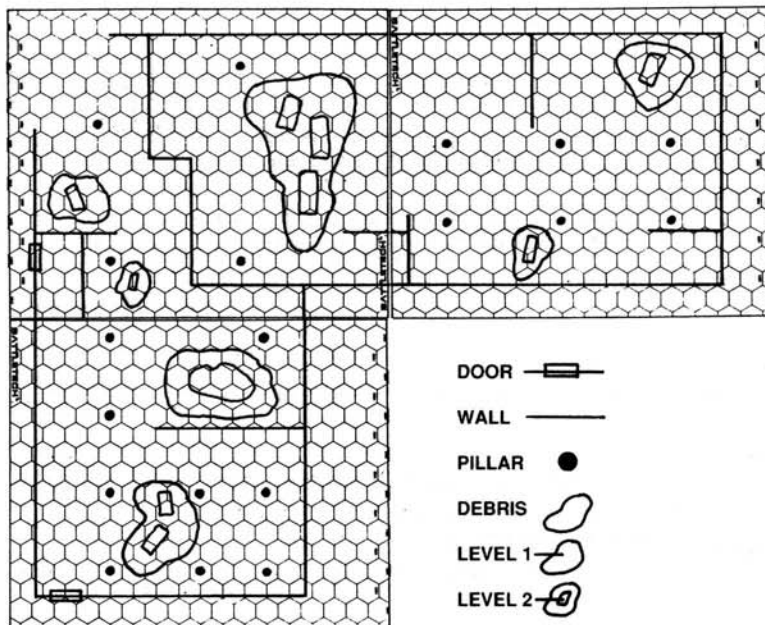

## DEFENDER

The Defender consists of elements of Snord's Irregulars Battalion.

### First (Command) Company, Rhonda Snord's Irregulars

#### Command Lance

Colonel Rhonda Snord (*Piloting 2, Gunnery 1*), *Highlander* (LL 10 points of armor, missing 3 Heat Sinks; CT 20 points of armor)

Dennis Maltesta (*Piloting 2, Gunnery 2*), *Excalibur*

David Rowsch (*Piloting 3, Gunnery 2*), *Guillotine* (LA 3 points of armor, LT 10 points of armor, Jump Jets inoperative)

Sharonus Wayne (*Piloting 3, Gunnery 2*), *Spartan* (CT 17 points of armor, RT 10 points of armor, 1 Medium Pulse Laser in RA not operational)

#### Attack Lance

Lieutenant Marcos Shake (*Piloting 2, Gunnery 1*), *Bombardier* (RA 4 points of armor, LA 5 points of armor)

Tempest Storm (*Piloting 3, Gunnery 2*), *Spartan*

Anthony Pryor (*Piloting 3, Gunnery 1*), *Lancelot*

Charlotte Deblois (*Piloting 3, Gunnery 1*), *Thug* (CT 10 points of armor, RA 2 points of armor, RT 10 points of armor)

#### Recon Lance

Lieutenant Cyndos Thomlinson (*Piloting 2, Gunnery 3*), *Mercury*

Adrian MacLeod (*Piloting 3, Gunnery 2*), *Hussar*

Walker Roche (*Piloting 3, Gunnery 2*), *Champion*

Arnold Ling (*Piloting 3, Gunnery 1*), *Kintaro*

**Second Company (Shorty's Scavengers)**

**Command Lance**

Captain Samuel "Shorty" Snee (Piloting 1, Gunnery 1), *Crockett*  
 Daniel Trump (Piloting 2, Gunnery 2), *Champion*  
 Marleen Danules (Piloting 4, Gunnery 2), *Crab*  
 Carter Malvinson (Piloting 4, Gunnery 3), *Black Knight*

**Support Lance**

Lieutenant Darrell Lanst (Piloting 3, Gunnery 3), *Padilla Artillery Tank*  
 Dorchester Quinn (Piloting 4, Gunnery 2), *Burke Heavy Tank*  
 Archie Ferris (Piloting 4, Gunnery 1), *Demon Armored Car*  
 Nathan "Beaver" Hauck (Piloting 2, Gunnery 3), *Rotunda Scout Car*

**Third Company**

**Support Platoons (Anti-Mech Trained)**

Sergeant Roger H'Chu, Veteran, Infantry (SRM)  
 Corporal Darwin "Breaker" Morgan, Elite, Motorized Infantry (Laser)

**Deployment**

The Defender must set up before play. The Second Company's Support Lance must set up on the east map.

All other BattleMechs and infantry may deploy anywhere on the maps to the west of the far east wall. Any infantry on the west maps may use the Hidden Deployment optional rule if they set up in hexes with Level 1 Debris.

**ATTACKER**

The Attacker is the Dark Wing Cluster of the Jade Falcons, with elements of Trinary Alpha, Alpha Probe Star, Trinary Bravo, Bravo Sweep and Hold Stars, and the Dark Wing Cluster Command Star.

**Command Star**

Star Colonel Damon (Piloting 2, Gunnery 1), *Thor* (RA gone)  
 Star Commander Veltix (Piloting 1, Gunnery 3), *Thor B* (RL 8 points of armor, LA 2 points of armor, CT 7 points of armor)  
 MechWarrior Trisha (Piloting 2, Gunnery 2), *Uller C* (RT has no armor, ammo, or equipment)  
 MechWarrior Unis (Piloting 2, Gunnery 3), *Uller* (LA gone, LL 2 points of armor)  
 MechWarrior Bhamenn (Piloting 3, Gunnery 4), *Uller B* (LL 3 points of armor, RA 2 points of armor)

**Trinary Alpha**

**Alpha Probe**

Star Commander Harris (Piloting 1, Gunnery 2), *Dasher B*  
 MechWarrior Tokko (Piloting 2, Gunnery 4), *Dasher A*  
 MechWarrior Robin (Piloting 1, Gunnery 3), *Dasher*  
 MechWarrior Gallis (Piloting 1, Gunnery 2), *Dasher D*  
 MechWarrior Stringfellow (Piloting 2, Gunnery 4), *Dasher*

Continued on page 64

One-on-one, Clan OmniMechs outmatched even the superior SLDF BattleMechs of Snord's Irregulars. Colonel Snord was well aware of this mismatch. When mapping out her strategy for dealing with the Dark Wing Cluster, she realized that the most efficient way to fight the Clansmen was to wear them down, rather than attempting one crushing defeat.

The battle on the surface was indecisive, but crippled some of the more potent Clan OmniMechs. Rhonda's forces retreated through Camelot Command's airlock and triggered a rock slide to cover the outside of the lock. This bought her troops an hour of repair time that the Clans were not allowed.

It also allowed her to stage an ambush in the warehouses of the old naval base.

The warehouses provided ideal terrain for an ambush, including pillars, doorways, thick walls, and mountains of packing crates. The Irregulars' armored vehicles could function in the pressurized rooms and were virtually undamaged. Her infantry could engage the enemy in relative safety as well.

Indoor combat is usually at deadly close range, using kicks, punches, and other physical attacks. The Clan warriors lacked the necessary equipment for this type of combat, and Rhonda felt that even this slight edge would help the Irregulars.

Once again, her plan was simple. She engaged the enemy in a series of quick ambushes, slowly pulling her forces out of the room. Once more the goal was to wear down the Jade Falcons. However, the Dark Wing Cluster had a few surprises of its own. They breached the wall in two places, almost turning the tide of battle in their favor. The Irregulars used their Beagle Probe to save the situation from becoming a disaster.

Rhonda and her forces inflicted heavy damage, then pulled back to the main reactor room for the final confrontation. One of her infantry platoons, meanwhile, found themselves against a star of Elementals in a pitched battle for the main control room of the base.

# PITCHED BATTLE



## PITCHED BATTLE rules continued

### Trinary Bravo

#### Bravo Supernova (Partial due to losses)

Star Captain Norris (*Piloting 1, Gunnery 1*), *Black Hawk* (RA, LA gone)  
 Point Commander Franklin, 3 Elementals  
 MechWarrior Carter (*Piloting 2, Gunnery 3*), *Puma B* (LT missing all armor/ammo/  
 weapons/equipment)  
 Point Commander Miki, 3 Elementals  
 MechWarrior Von-Kapper (*Piloting 2, Gunnery 3*), *Uller* (RA gone)  
 Point Commander Asaki, 1 Elemental

#### Bravo Sweep

Star Commander Ultor (*Piloting 1, Gunnery 2*), *Koshi B*  
 MechWarrior Flange (*Piloting 1, Gunnery 2*), *Dasher A*  
 MechWarrior Durg (*Piloting 3, Gunnery 4*), *Dasher C*  
 MechWarrior Terrence (*Piloting 2, Gunnery 3*), *Uller*  
 MechWarrior Brace (*Piloting 3, Gunnery 3*), *Dasher*

### Deployment

The Attacker may set up anywhere east of the far east wall.

### VICTORY CONDITIONS

The Attacker has two goals, to engage and destroy the Irregulars and to move through the warehouse exit into the station. The victory conditions reflect this.

The Defender wants to inflict as much damage as possible while withdrawing functional 'Mechs for later engagements with the enemy.

The Attacker (Jade Falcons Dark Wing Cluster) is awarded points for actions completed by the end of Turn 20. If these points are positive, the Attacker wins. If these points are negative, the Defender wins.

### VICTORY TABLE

Points	Action
3	Each Defender's unit destroyed
3	Each Attacker's BattleMech exited through the large door on the southwest map
1	Each Attacker's Elemental exited through the large door on the southwest map
2	Each Attacker's Elemental exited through the smaller door on the southwest map (at Hex 0416)
-3	Each Defender's unit exited through the doors on the southwest map
-4	Each Attacker's unit destroyed or unable to move

### SPECIAL RULES

Use optional rules in the **BattleTech Compendium** for **Anti-BattleMech Infantry** (pp. 47-8) and **Hidden Units** (p. 57), as well as those given in **Campaign Rules** under **Indoor Combat**.

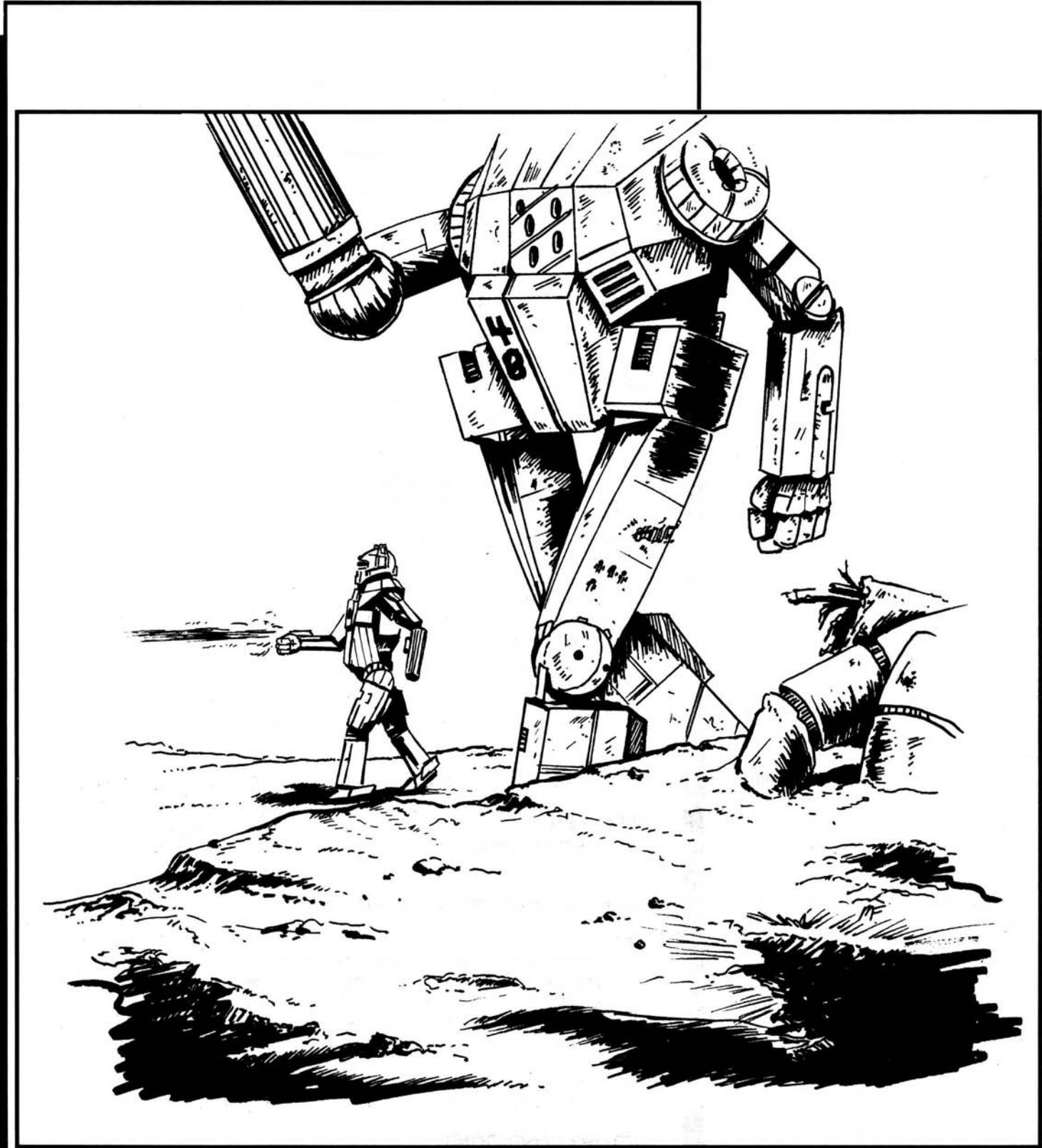



# MEN-AT-ARMS: Scenario 5

## FIGHTING ON THE FLOOR

—Excerpted from *Toad Men From Hell, The First Clan War*, by Lieutenant Fasha Nagaraj, Commonwealth Press, 3053

Colonel Snord informed me that I was being given a "unique" mission. In the Irregulars, everything we did was a little unique, but I knew by her tone that this was something pretty serious.

No matter how bad the fighting became, we were to hold the base command center. Apparently she was afraid of the Clanners getting their hands on our life support and power controls. I can't say that I blamed her.

We all heard the rumblings from the warehouses in the outer levels. Our point man, Corporal Stephanie Labby, signaled that we had company coming.

The figure that stepped into the corridor seemed to have stepped out of a nightmare. Over two and a half meters tall, it was a monster. It looked all new and shiny, with a pair of dark green wings painted on the helmet. It looked around as I brought my laser to bear.

Four of us hit it together and hit it hard. When the lasers stopped firing, all I saw were a few small, smoldering holes in its chest. It seemed a little miffed that we had even dared fire at it. It seemed to move in slow motion, raising its left arm and blasting me with its laser.

I smelled the impact more than felt it. I remember looking down and seeing the stump where my right hand had been. The laser had almost cut my rifle in half. I looked back up at that machine and saw it working on the rest of the squad.

One of the men, a young turk named MacAfy, bolted from behind a desk and tried to jump the Toad-Trooper. With one swift swing of its mechanical claw, it tossed MacAfy aside like a rag doll. MacAfy spent over three months in traction for that little mistake.

I opted for a more traditional approach. I pulled the firing tape on my grenade with my teeth and tossed it left-handed at that monster. Mine was the first, but there were several others following. It took some time, but before it was over, that Toad Man from Hell and the one that followed him were nothing more than smoldering slag piles.

## GAME SET-UP

Lay out the maps as shown. Only the two highlighted buildings are used in this scenario. This scenario uses standard **BattleTroops** rules, with modifications listed under **Special Rules**.

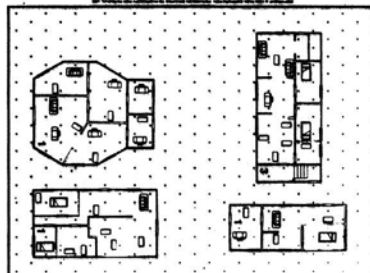

## DEFENDER

The Defender consists of the Snord's Irregulars Third Company's First Infantry Platoon, totaling 12 personnel, including the two leaders.

### Leaders

Lieutenant Fasha Nagaraj, Elite  
Sergeant Baca Tsaprazis, Veteran

All troops are equipped with full Combat Armor. The following weapons are available for use by the Defender:

- 1 Semi-Portable Heavy Laser
- 2 Heavy SRM Launchers
- 1 LAW
- 4 Auto Grenade Launchers
- 2 Satchel Charges
- 2 Gyrojet Rifles
- 3 Laser Rifles

Each Irregular carries two grenades and a Vibro-Blade.

### Deployment

The Defender sets up first, anywhere in the two rooms used in the scenario.

## ATTACKER

The Attacker consists of Elementals of the Trinary Bravo, Bravo Supernova, and Bravo Hold Stars.

### Remnants, Trinary Bravo Elementals

### Leaders

Elemental Yoshi, Veteran, Flamer and Gyrojet Rifle  
Elemental Tarra, Regular, Laser and Gyrojet Rifles  
Elemental Jacob, Regular, Flamer and Laser Rifle  
Elemental Tikkison, Green, Flamer and Gyrojet Rifle  
Elemental Zoran, Regular, Flamer and Gyrojet Rifle

### Deployment

The Attackers move into the stairwell of Building 3 at the beginning of Turn 1.

## VICTORY CONDITIONS

The game length is 30 turns. The Attacker (Jade Falcons) wins by having at least two Elementals in the north room within one hex of the north wall, and no opposing forces in the same room or in line-of-sight. Any other outcome is a Defender (Irregulars) victory.

10	9	8	7	6	5	4	3	2	1	Armor Destroyed	
15	15	15	12	12	12	10	10	10	8	xx	xx
10	9	8	7	6	5	4	3	2	1	0	DEAD
8	8	8	+1	+1	+2	+2	+2	+3	+3	NONE	

Troop Number \_\_\_\_\_ Primary Weapon Type: \_\_\_\_\_ MP \_\_\_\_\_  
 Dmg: \_\_\_\_\_ Short \_\_\_\_\_ Long \_\_\_\_\_

SRM ○ ○ ○ ○ Secondary Weapon Type: \_\_\_\_\_ MP \_\_\_\_\_  
 Dmg: \_\_\_\_\_ Short \_\_\_\_\_ Long \_\_\_\_\_

Other Ammo ○ ○ ○ ○

**SPECIAL RULES**

Use the following optional rules from **BattleTroops: Leadership, Area-Effect Weapons, Anti-Mech Fire** (for satchel charges), and **Support Weapons.**

**Interiors**

Treat all windows as solid walls.

For this scenario, consider the two rooms joined as indicated in this illustration:

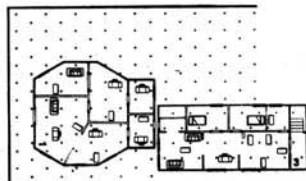

**Elementals**

The following rules are designed for quick and effective introduction of Elementals into **BattleTroops.**

Elementals cannot use hand grenades, but can place satchel charges.

**Elemental Armored Protection**

The Elemental Armored Combat Suits can withstand major damage and will medicate the warrior using it. Use the above Record Sheet for Elementals in combat.

Elementals have 15 MP and start with no damage. The armored suit absorbs damage as normal combat armor without the movement point penalties. Elemental combat suits can lose the first eight blocks without suffering a movement modifier.

The record sheet shows three boxes marked with XXs. At each of these levels, one of the Elementals' weapons has been damaged. The damaged weapon is determined by the opposing player.

Vibro-blades may be used against Elementals. Players may also plant satchel charges on Elementals, per the **Anti-Mech** rules.

**Elemental Weapons**

Each Elemental is equipped with an SRM-2 pack, as indicated on the record sheet. Each is also equipped with a primary attack weapon (Right Arm) and a secondary attack weapon (slung under the Left Arm). Each Elemental has a manipulable claw.

For combat purposes, each Elemental weapon has its own firing arcs, and these must be placed separately.

An Elemental's manipulable claw does (MP/2) +2 Lethal Damage.

The following weapons may be attached as primary and secondary weapons:

	Base 6		Base 8	
	APV*	Damage	Short Range	Long Range
Small Personal Laser	2	12L	1-90	91-270
Gyrojet Rifle	0	7L	1-60	61-200

(\*Armor Piercing Value for **BattleTech** conversion.)

Star Colonel Damon had read most of the reports on the Inner Sphere and their fighting tactics as they had filtered down through Clan Jade Falcon's intelligence net. What he read led him to believe that many of the Inner Sphere units fought in a way the Clans found dishonorable.

During the operation against Snord's Irregulars inside Camelot Command, he feared that, if pressed, the Irregulars might cut off life support or other vital power systems on the station. After securing the warehouse bays, with considerable losses on both sides, he sent several Elementals down to the command center to hold it should the Irregulars choose a deadly alternative to surrender.

The hallways and other areas leading to the command center were rigged with booby traps, thanks to the efforts of the Irregulars' First Jump Platoon under the command of Lieutenant Fasha Nagaraj and Sergeant Baca Tsaprazis. After sustaining losses during the initial confrontation with the Jade Falcons, the platoon was looking for revenge.

A handful of Elementals managed to reach the outer hallway of the command center, where the Irregulars' platoon had decided to make its final stand. In the tight confines of the corridors, it was difficult for the Elementals to operate to their full advantage. In the end, though, it cost the lives of many Irregulars to fight the Elementals to a standstill.

# BIRTH OF A LEGEND: Scenario 6

## AN HONORABLE END

"Rhonda," Cranston asked, "just how bad was the battle in the engineering bay?"

Rhonda closed her eyes for a moment, pained at the memory of the deadly battle. "We had whittled them down quite a bit, Father, but they had hurt us as well. Charlotte's *Thug* was a shell, and Rowsch and his *Guillotine* were also in bad shape. We lost a full platoon of ground troops, too. The last I saw of Beaver's Rotunda, a Jade Falcon had turned it into a roller skate.

"By the time they reached the engineering bays, they had lost a lot of good men and women. We had mauled them enough to make the outcome look good for our side. Star Colonel Damon's forces breached the outer wall in two places, and they hit us hard. Before things got too far out of hand, though, I managed to find and duel him. Both of us were in pretty sorry shape, but in the end I smashed his *Thor* with a series of punches and kicks that took it down.

"The remaining Jade Falcons went into a frenzy over his defeat; I guess at the time they thought he was dead. If not for some fancy footwork by Darkside Burns and Adrian MacLeod in cutting them off, I think they might have broken away and fired at the reactor."

Cranston looked slightly bemused. "I'm a little shocked that they would try for the main reactor. The explosion and hot core breach would have cut right through to the surface. The entire base would have been wiped out."

"Father, these Jade Falcons had nothing to lose. They were older warriors and those who had tested out of better positions in the Clan. For them, death in a pitched battle was an honorable end. Like our own Wolf Clan's Epsilon Galaxy, they believed this honorable death was all they had left.

"Now—now they have a new Clan and new Khans to follow. At first I thought when we defeated them and they finally surrendered, that they would collapse. Now I see that this is not the case. We have forged something new—something deadly. We have begun our own Clan, Father, and perhaps a new era."

## GAME SET-UP

Lay out the maps as shown. Use the blank sides of **BattleTech** map boards for the engineering bay. Mark or lay counters, paper strips, and so on to indicate walls, doors, debris, and pillars.

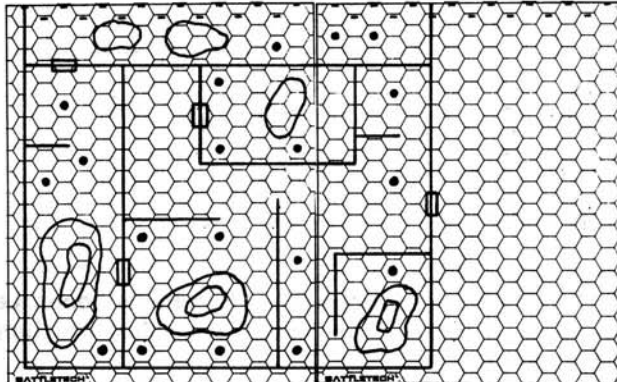

## DEFENDER

The Defender consists of elements of Snord's Irregulars. Their units are damaged as indicated.

### First (Command) Company, Rhonda Snord's Irregulars

#### Command Lance

Colonel Rhonda Snord (*Piloting 2, Gunnery 1, Highlander*  
(LL 3 points of armor, missing 3 Heat Sinks, CT 4 points of armor, RA 5 points of armor, RL 5 points of armor)  
Dennis Maltesta (*Piloting 2, Gunnery 2, Excalibur*  
(LA all equipment/weapons gone, LT 4 points of armor, LL 5 points of armor)

#### Recon Lance

Adrian MacLeod (*Piloting 3, Gunnery 2, Hussar*)

### Second Company (Shorty's Scavengers)

#### Command Lance

Carter Malvinson (*Piloting 4, Gunnery 3, Black Knight*  
(H 1 point of armor, RA 4 points of armor, LL 14 points of armor, RL 3 points of armor, LT 17 points of armor, CT 17 points of armor, RT 11 points of armor)

### Third Company

#### Fire Lance

Lieutenant Bright Thomlinson (*Piloting 2, Gunnery 1, Crockett*  
Linda Thomlinson (*Piloting 4, Gunnery 1, Flashman*  
Blade Windall (*Piloting 1, Gunnery 2, Highlander*  
Dalid "Darkside" Burns (*Piloting 5, Gunnery 3, Enforcer*)

### Support Platoons (Anti-Mech Trained)

Sergeant Roger H'Chu, Veteran, Infantry (SRM)  
Corporal Darwin "Breaker" Morgan, Elite, Motorized Infantry (Laser)

## Deployment

Snord's Irregulars set up anywhere inside the rooms on the maps.

**ATTACKER**

The Attacker consists of the remnants of the Dark Wing Cluster of the Jade Falcons. Their units are damaged as indicated.

**Dark Wing Command**

Star Colonel Damon (*Piloting 2, Gunnery 1*), *Thor*  
 (RA gone, LA no armor, LB 10X gone, Ammo (LRM) 3 reloads, CT 13 points of armor, RT 5 points of armor)  
 MechWarrior Unis (*Piloting 2, Gunnery 3*), *Uller*  
 (CT armor gone, LA gone, Ammo (AC) 6 reloads, LL 2 points of armor, LA 3 points of armor)

**Trinary Alpha**

**Alpha Shield**

Star Commander Yolls (*Piloting 1, Gunnery 2*), *Ryoken (B)*  
 (LA gone, RA 5 points of armor, LL no armor, RT no armor, 2 Double Heat Sinks gone)  
 MechWarrior Adrian (*Piloting 3, Gunnery 3*), *Ryoken (A)*  
 MechWarrior Savrus (*Piloting 3, Gunnery 4*), *Mad Cat (D)*  
 (RA gone, RT gone, LL 10 points of armor, RL 14 points of armor, LA 8 points of armor, LT 14 points of armor, CT 11 points of armor)  
 MechWarrior Shultz (*Piloting 1, Gunnery 3*), *Mad Cat*  
 (LT gone (two engine hits, LA non-functional), CT 20 points of armor, CT (rear) no armor, RA 6 points of armor, LA no armor, LL 22 points of armor)  
 MechWarrior Terry (*Piloting 2, Gunnery 3*), *Ryoken (C)*  
 (RA gone, RT no armor, CT 6 points of armor, LL 10 points of armor, RL 4 points of armor)

**Trinary Bravo**

**Bravo Supernova**

Star Captain Norris (*Piloting 1, Gunnery 1*), *Black Hawk*  
 (RA gone, LA gone, CT 4 points of armor, RT 3 points of armor, LT 10 points of armor)  
 Point Commander Franklin, 1 Elemental

**Bravo Sweep**

Star Commander Ultor (*Piloting 1, Gunnery 2*), *Koshi (B)*

**Bravo Hold**

Elemental Star Commander Holly, 2 Elementals  
 Point Commander Diane, 4 Elementals  
 Point Commander Front, 3 Elementals  
 Point Commander Debby, 1 Elemental

**Deployment**

The Attacker sets up anywhere to the east of the rooms.

**VICTORY CONDITIONS**

The Attacker (Jade Falcons) wins by having at least 4 intact Elementals or 2 intact BattleMechs in the room indicated at the end of Turn 15. This may be done by breaching the doors or walls. Any other result is a Defender (Irregulars) victory.

**SPECIAL RULES**

Use the **BattleTech** optional rules for **Anti-BattleMech Infantry** and **Hidden Units**. Also use the **Indoor Combat** rules given in **Campaign Rules**.

The final battle for Camelot Command took place at the center of the planetoid near the main fusion reactor housing. Through a series of blockades and barricades carefully set between the warehouses and the engineering bays, Snord's Irregulars were able to slow the advance of the Jade Falcons long enough to conduct a few emergency repairs and ready the almost-empty engineering bay for a final battle.

Colonel Snord was concerned that the Falcons would damage the reactor coolant system and the super-heated core would melt through the decks and to the planetoid's surface. The resulting explosive decompression would likely kill nearly everyone. She was counting on having worn down the Dark Wing Cluster enough to defeat them with one quick blow in this battle.

A key part of the plan was the Third Company's Fire Lance under the command of Bright Thomlinson, which Rhonda had held back for this battle. Two platoons of the Irregulars' elite Anti-Mech Infantry also had been placed in reserve in the engineering bays to await the arrival of the Clan OmniMechs.

Colonel Snord was not aware that Star Colonel Damon had held back almost a full Star of Elementals from his Trinary Bravo, hoping that these troops would turn the tide in the Clan's favor in the final battle. However, the Colonel underestimated the Irregulars. He was counting on them being beaten and weakened, not desperately strong.

The fighting was fierce, with Star Colonel Damon finally falling to Rhonda Snord's *Highlander*. As the Third Company's Fire Lance devastated the Elementals of Bravo Hold Star, the last of the Irregulars prevented the Jade Falcons, despairing over their loss, from reaching the reactor core.

After a few tense moments, the Colonel emerged from what was left of his *Thor* and conceded defeat to Snord's Irregulars. He immediately ordered his command to cease hostilities and surrender. Within the space of several seconds, Snord's Irregulars had changed dramatically. No longer a band of misfit mercenaries, they were now Clan Snord, a unit of almost regimental size, boasting warriors of the highest caliber.



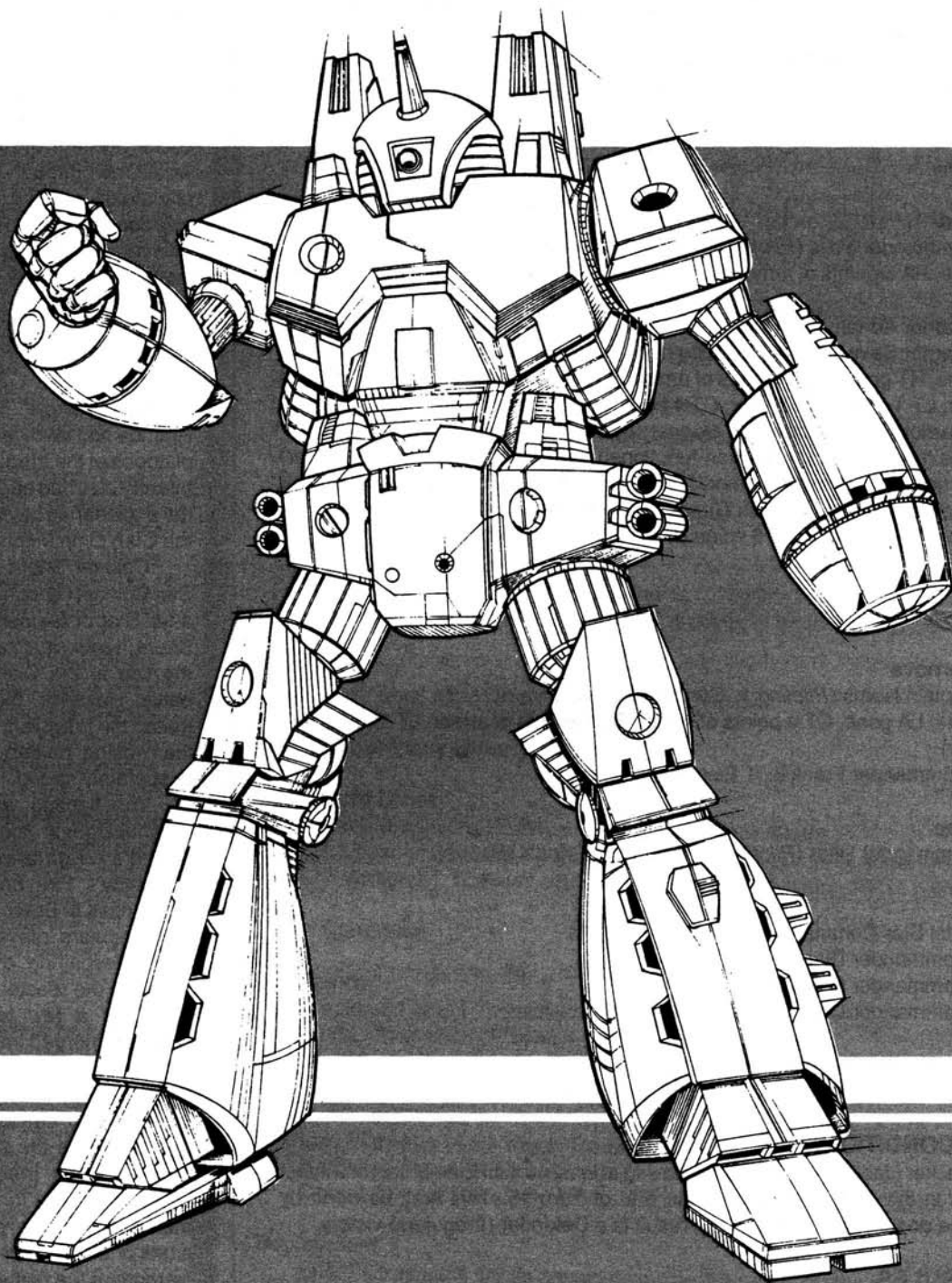

CHOOSE YOUR WEAPONS WELL:

# PARTHA POWER!

BATTLE WITH THE BEST!

20 815	ARC 4R ARCHER	_____	\$4 00	20 870	WTH 1 WHITWORTH	_____	3 50
20 845	AS 7D ATLAS	_____	5 00	20 871	VND 1R VINDICATOR	_____	3 50
20 847	AWS 80 AWESOME	_____	4 50	20 872	OKD 4G QUICKDRAW	_____	4 00
20 848	ON1 K ORION	_____	4 00	20 873	SDR 5V SPIDER	_____	3 00
20 849	CN9 A CENTURION	_____	3 50	20 874	OTT 7J OSTSCOUT	_____	3 00
20 851	VLK 0A VALKYRIE	_____	3 00	20 875	ASN 21 ASSASSIN	_____	3 50
20 852	CPLT CI CATAPULT	_____	4 00	20 876	DV 6M DERVISH	_____	3 50
20 854	HBK 4G HUNCHBACK	_____	3 50	20 877	OSR 2C OSTROC	_____	4 00
20 855	OTL 4D OSTSOL	_____	4 00	20 880	BJ 1 BLACKJACK	_____	3 50
20 856	ZEU 6S ZEUS	_____	4 50	20 881	CGR 1A1 CHARGER	_____	4 50
20 858	CDA 2A CICADA	_____	3 50	20 882	BNC 3E (BNC S) BANSHEE	_____	5 00
20 859	SCP 1N SCORPION	_____	4 00	20 883	WSP 10S WASP LAM	_____	3 50
20 860	VTR 9B VICTOR	_____	4 50	20 884	PHX HKW PHOENIX HAWK LAM	_____	4 00
20 862	STK 3F STALKER	_____	4 50	20 885	HER 2S HERMES II	_____	3 50
20 863	CP10 Z CYCLOPS	_____	5 00	20 886	VL2T VULCAN	_____	3 50
20 864	HCT 3F HATCHETMAN	_____	3 50	20 887	TBT 5N TREBUCHET	_____	3 50
20 865	COM 2D COMMANDO	_____	3 00	20 888	GHR 5H GRASSHOPPER	_____	4 00
20 868	DRG 1N DRAGON	_____	4 00	20 889	LGB 0W LONGBOW	_____	4 50

To place an order call toll free 1 (800) 543-0272 or send \$3.00 for our complete photo catalog to:  
RAL PARTHA ENTERPRISES, INCORPORATED, 5938 Carthage Court, Cincinnati, OH 45212

RAL PARTHA miniatures are also available from  
MINIFIGS 1/5 Graham Road, Southampton, England SO2 0AX

RAFM 20 Park Hill Road East, Cambridge, Ontario, Canada N1R1P2  
JEUX DESCARTES S, Rue De LaBaume, 75008, Paris, France

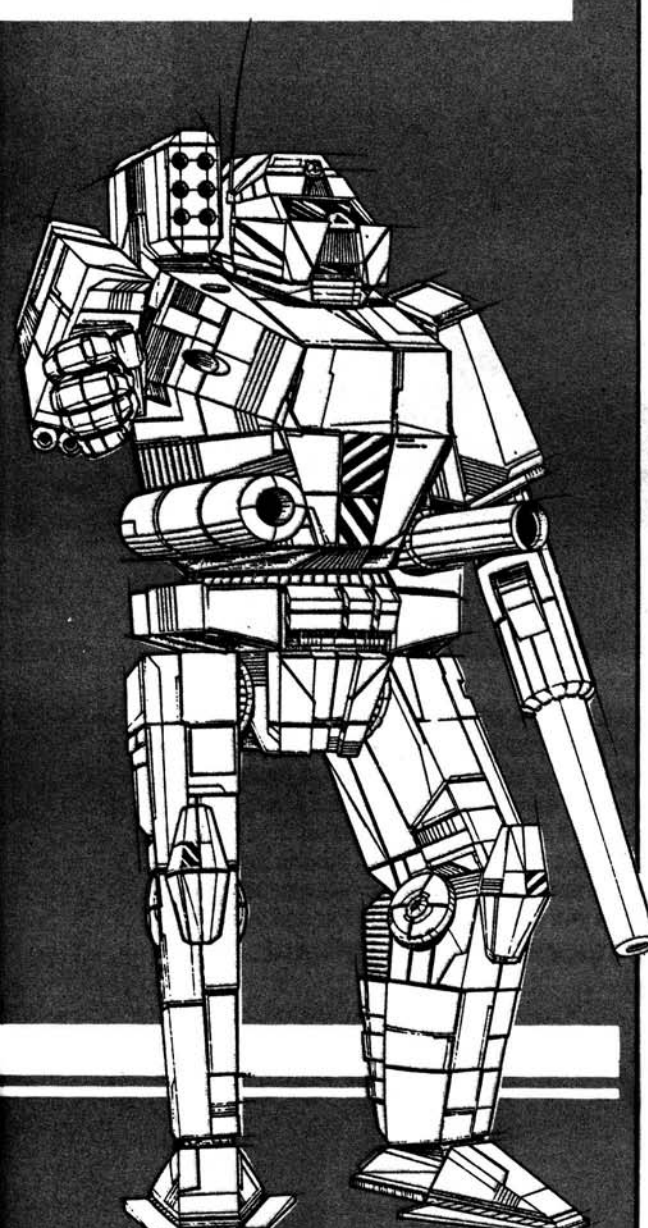

# BATTLETECH

## THE CRESCENT HAWK'S REVENGE



True 256-color graphics  
Digitized speech  
Advanced sound support

You are Jason Youngblood . . .

In **BATTLETECH: THE CRESCENT HAWK'S INCEPTION**, your father was taken prisoner by House Kurita. But now, in **THE CRESCENT HAWK'S REVENGE**, you lead your bold Lance against Kurita in a daring mission of rescue and revenge. Then defy the greatest threat ever to the Inner Sphere—the Clans, who have 'Mechs and weapons like nothing ever seen before.

FASA's entire BATTLETECH universe comes to life in **THE CRESCENT HAWK'S REVENGE**. Featuring over 50 kinds of 'Mechs—including the brand new OmniMechs—plus tanks, aerofighters, infantry and other BATTLETECH units. 21 compelling scenarios on five planets. And an engaging storyline that changes with the outcome of every decision you make, every battle lost and won.

**THE CRESCENT HAWK'S REVENGE.**



21 scenarios of 31st-century political and military strife, set on five planets. All in true 256-color graphics, plus advanced sound support.

**NEW**  
from  
  
**INFOCOM**



**Unique real-time combat system.** Get constant reports from your forces, hear digitized radio messages, see the results of your orders—instantly.

**THE CRESCENT HAWK'S REVENGE**, available October 1990 for MS-DOS computers.

See your local retailer or call 1-800-227-6900 to order.

MECHWARRIOR and BATTLETECH are registered trademarks and BattleMech and 'Mech are trademarks of FASA Corporation. Board game design, characters, and universe ©1988 FASA. MS-DOS is a trademark of Microsoft Corp.





# RHONDA'S

## IRREGULARS

*HELP,  
HELP ME,  
RHONDA!*

In 3307, Cranston Snord's Irregulars emerged from the winnings of a poker game. Under the command of Cranston Snord, an officer disgraced and discharged from Wolf's Dragoons, the Irregulars gained a reputation for unorthodox tactics and a fetish for collecting lost artifacts and treasures. Now, 43 years later, Cranston has given his daughter Rhonda active command of the Irregulars. Under her leadership, the Irregulars have grown in size and reputation.

The Federated Commonwealth command used the Irregulars against House Marik with satisfying results, and they looked the other way when the Irregulars went collecting. Now, the battered Federated Commonwealth wants the Irregulars to conduct raids into Clan-held territory. The Irregulars are willing to take on the Clans, but they have another objective in mind; a Star League naval base believed to be deep inside Clan-held territory.

Rhonda's Irregulars is a BattleTech scenario pack chronicling the Irregulars' history from Cranston's discharge from Wolf's Dragoons, to their actions in the Fourth Succession Wars, to their battles, including Operation Merlin, the Irregulars' foray into Clan territory. Also included are new 'Mechs and vehicles used by the Irregulars, unit rosters, and personnel files.



BATTLETECH® is a Registered Trademark of FASA Corporation.  
RHONDA'S IRREGULARS is a Trademark of FASA Corporation.  
Copyright © 1991 FASA Corporation. All Rights Reserved.  
Printed in the United States of America.

